

marantz[®]

Super Audio CD Player

SA8005

You can print more than one page of a PDF onto a single sheet of paper.

[Front panel](#)[Display](#)[Rear panel](#)[Remote](#)[Index](#)

Owner's Manual

Contents

Accessories	<u>4</u>
Inserting the batteries.....	<u>5</u>
Operating range of the remote control unit.....	<u>5</u>
Features	<u>6</u>
High quality sound.....	<u>6</u>
High performance.....	<u>6</u>

Part names and functions

Front panel	<u>8</u>
Display	<u>10</u>
Rear panel	<u>11</u>
Remote control unit	<u>12</u>
CD player operations.....	<u>12</u>
Amplifier operations.....	<u>15</u>
Network audio player operations.....	<u>16</u>

Connections

Connecting an amplifier	<u>18</u>
Connecting a device equipped with digital audio input connectors	<u>19</u>
Connecting a device equipped with digital audio output connectors	<u>20</u>
Connecting a PC or Mac	<u>21</u>
Connecting an iPod or USB memory device to the USB port	<u>22</u>
Remote control connection	<u>24</u>
Connection.....	<u>24</u>
Setting.....	<u>24</u>

Connecting the timer device	<u>25</u>
Connecting the power cord	<u>26</u>

Playback

Basic operation	<u>28</u>
Turning the power on.....	<u>28</u>
Select the playback media mode.....	<u>29</u>
Switching the display's brightness.....	<u>29</u>
Stopping digital outputs.....	<u>29</u>
Setting the top priority playback layer for Super Audio CDs.....	<u>30</u>
Playing CDs/Super Audio CDs	<u>31</u>
Playing CDs and Super Audio CDs.....	<u>31</u>
Playing tracks in a specific order (Program playback).....	<u>33</u>
Playing DATA CDs	<u>34</u>
Playing files.....	<u>35</u>
Playing an iPod	<u>37</u>
Listening to music on an iPod.....	<u>38</u>
Setting operation mode (Remote iPod mode).....	<u>39</u>
Playing a USB memory device	<u>41</u>
Playing files stored on USB memory device.....	<u>42</u>
Using as a D/A converter	<u>44</u>
Connecting and playing back from a computer (USB-DAC).....	<u>45</u>
Connect and playback from a digital device (Coaxial/Optical).....	<u>51</u>



Settings

Menu map	<u>52</u>
Menu operation.....	<u>53</u>
Timer Play	<u>54</u>
Disp Info	<u>54</u>
iPod.....	<u>54</u>
USB.....	<u>54</u>
USB Resume	<u>55</u>
Digital Out	<u>55</u>
Auto Stnby	<u>55</u>

Tips

Contents	<u>56</u>
Tips.....	<u>57</u>
Troubleshooting.....	<u>58</u>

Appendix

Playable media.....	<u>64</u>
Discs.....	<u>64</u>
DATA CD.....	<u>65</u>
USB memory device.....	<u>65</u>
Playback order of MP3/WMA/AAC/WAV files.....	<u>67</u>
About Discs and Files.....	<u>67</u>
D/A converter.....	<u>68</u>
Cautions on using media.....	<u>69</u>
Inserting a disc.....	<u>69</u>
How to handle media.....	<u>70</u>
Cleaning discs.....	<u>70</u>
Explanation of terms.....	<u>71</u>
Trademark information.....	<u>72</u>
Specifications.....	<u>73</u>
Index.....	<u>75</u>



Thank you for purchasing this Marantz product. To ensure proper operation, please read this owner's manual carefully before using the product. After reading them, be sure to keep them for future reference.

Accessories

Check that the following parts are supplied with the product.

① Getting Started

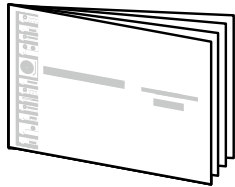

② CD-ROM (Owner's Manual)

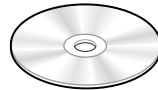

③ Safety Instructions

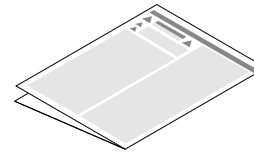

④ Power cord

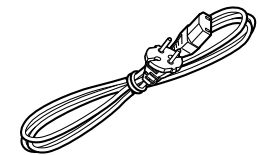

⑤ Remote control unit (RC002PMSA)

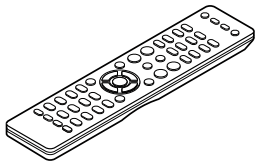

⑥ R03/AAA batteries

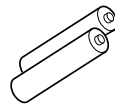

⑦ Audio cable

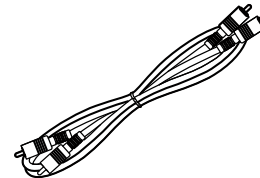

⑧ Remote connector cable

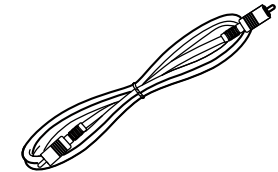

Inserting the batteries

- ① Remove the rear lid in the direction of the arrow and remove it.

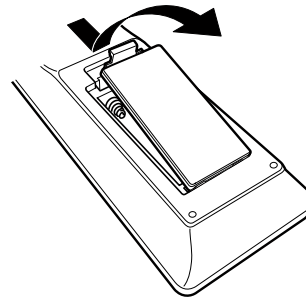

- ② Load the two batteries properly as indicated by the ⊕ and ⊖ marks in the battery compartment.

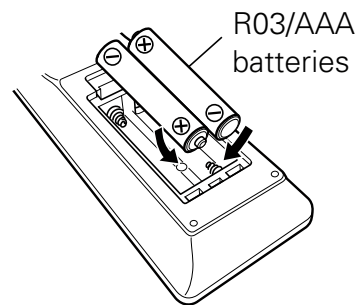

- ③ Put the rear cover back on.

NOTE

- When inserting the batteries, be sure to do so in the proper direction, following the ⊕ and ⊖ marks in the battery compartment.
- To prevent damage or leakage of battery fluid:
 - Do not use a new battery together with an old one.
 - Do not use two different types of batteries.
- Remove the batteries from the remote control unit if it will not be in use for long periods.
- If the battery fluid should leak, carefully wipe the fluid off the inside of the battery compartment and insert new batteries.

Operating range of the remote control unit

Point the remote control unit at the remote sensor when operating it.

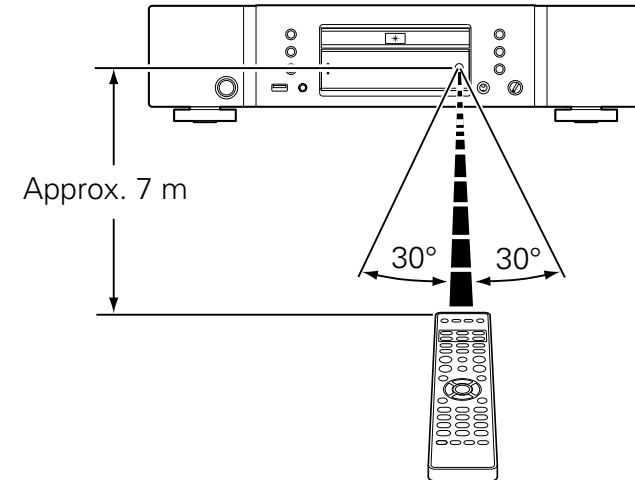

Features

High quality sound

- **Toroidal transformer**

This unit features a toroidal transformer that produces less vibration and magnetic leakage flux compared to conventional power transformers. The materials and manufacturing process of the ring-shaped core are strictly controlled to reduce vibration, while the short-ring attached to the perimeter of the transformer reduce magnetic leakage flux.

- **Large-capacitance block capacitor**

A large capacitance 3300 μ F capacitor carefully selected for its acoustic characteristics is incorporated into the power supply circuit.

- **Audiophile-grade film capacitors and electrolytic capacitors**

The unit's features the same audiophile-grade film capacitors and electrolytic capacitors specifically used in top-range models.

- **Low-noise low-distortion filter circuit and highspeed HDAM[®]SA2-type output amplifier with the differential input type HDAM[®]**

- **Double-layered chassis**

- **Headphone circuit component upgrade**

The high-grade headphone circuit incorporates HDAM[®]SA2 amplifier to enable headphone listening of high quality sound reproduction, late at night or in other such situations.

High performance

- **Equipped with a USB-DAC function to support DSD file playback**

This unit is equipped with a USB-DAC function that supports DSD signals and 192 kHz/24 bit PCM signals. You can enjoy high-quality audio playback from the D/A converter built in to this unit by inputting PCM signal or DSD signal music files into this unit from a computer via USB connection.

- Install the dedicated driver software onto the computer before use ("Installing the driver software" (page 45)).
- You can use whichever commercially available or downloadable player software you like to playback files on your computer.

- **Can be used as a D/A convertor**

Digital audio signals input from an external device or computer into this unit can be converted and output as analog signals using this unit's D/A converter.

- **Plays USB memory devices (MP3/WMA/AAC/WAV) and iPod[®]/iPhone[®]**

This unit can playback music stored on an USB memory device or iPod/iPhone.



- **Supports MP3 and WMA file playback (👉 page 34)**

MP3 and WMA files that have been recorded onto CD-R or CD-RW discs can be played back on this CD player.

- **Peripheral circuitry off function minimizes audio output signal interference**

In order to minimize noise from peripheral circuitry which could interfere with the analog audio signal, this unit is equipped with a peripheral circuitry off function which turns off the digital output circuit and the display.

- **iPod auto detect charges your device even after this unit switches to standby mode**

- **Auto Standby mode for energy savings**



Part names and functions

Front panel

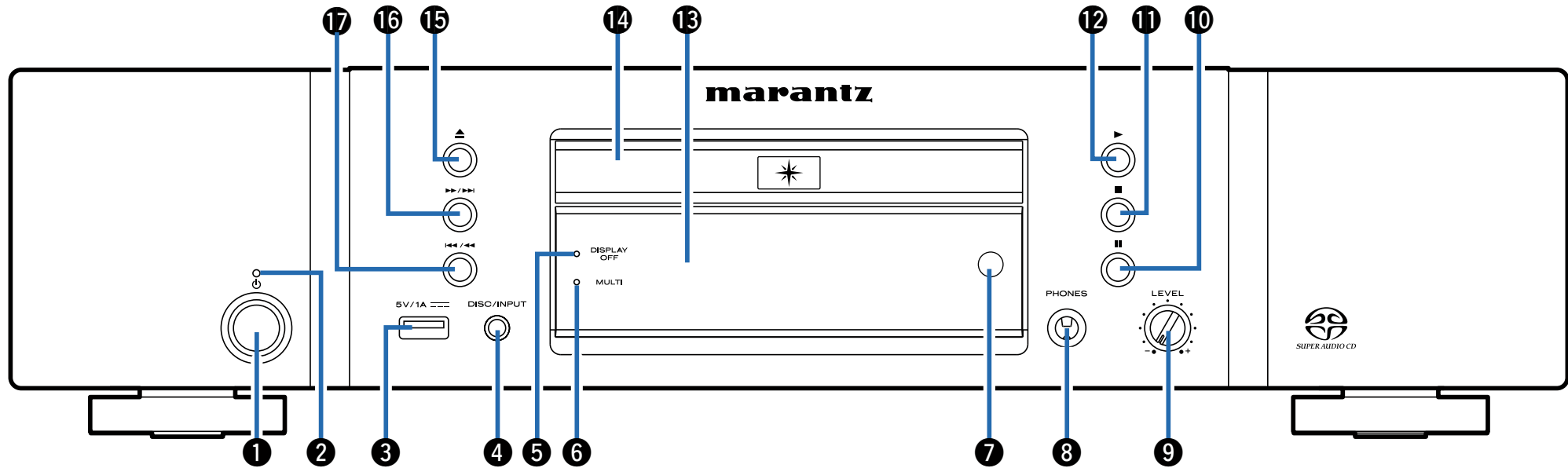

1 Power operation button (⏻)

Used to turn the power on/off (standby) (🔗 page 28).

2 Power indicator

This is lit as follows according to the power status :

- Power on: Off
- Standby: Red
- iPod charge standby : Orange

3 USB port

Used to connect USB storages (such as USB memory devices) and the USB cable supplied with iPod (🔗 page 22).

4 DISC/INPUT button

Used to select the playback media mode (🔗 page 29).

5 DISPLAY OFF indicator

Lights when the display is off (🔗 page 29).



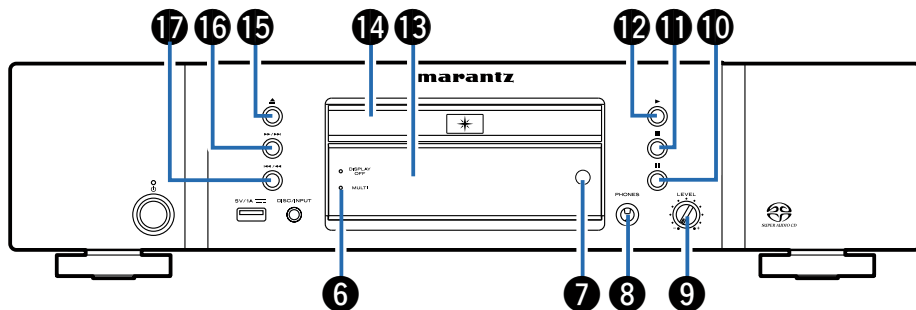

6 Multi layer indicator (MULTI)

This indicator lights up when the Multi channel area of a Super Audio CD is selected (☞ page 30).

7 Remote control sensor

This receives signals from the remote control unit (☞ page 5).

8 Headphones jack (PHONES)

Used to connect headphones.

NOTE

- To prevent hearing loss, do not raise the volume level excessively when using headphones.

9 Headphone volume control knob (LEVEL)

Adjusts the headphone volume.

10 Pause button (II)

Pauses playback (☞ page 32, 35, 39, 42).

11 Stop button (■)

Stop playback (☞ page 32, 35, 39, 42).

12 Play button (▶)

Starts playback (☞ page 32, 35, 39, 42).

13 Display

This displays various pieces of information (☞ page 10).

14 Disc tray

Used to insert a disc (☞ page 69).

15 Disc tray open/close button (▲)

Opens and closes the disc tray (☞ page 31).

16 Fast-forward/Forward-skip button (▶▶/▶▶▶)

Plays the next track. Press and hold to fast-forward the track (☞ page 32, 35, 39, 42).

17 Fast-reverse/Reverse-skip button (◀◀/◀◀◀)

Returns to the start of the currently playing track. Press and hold to fast-reverse the track (☞ page 32, 35, 39, 42).



Display

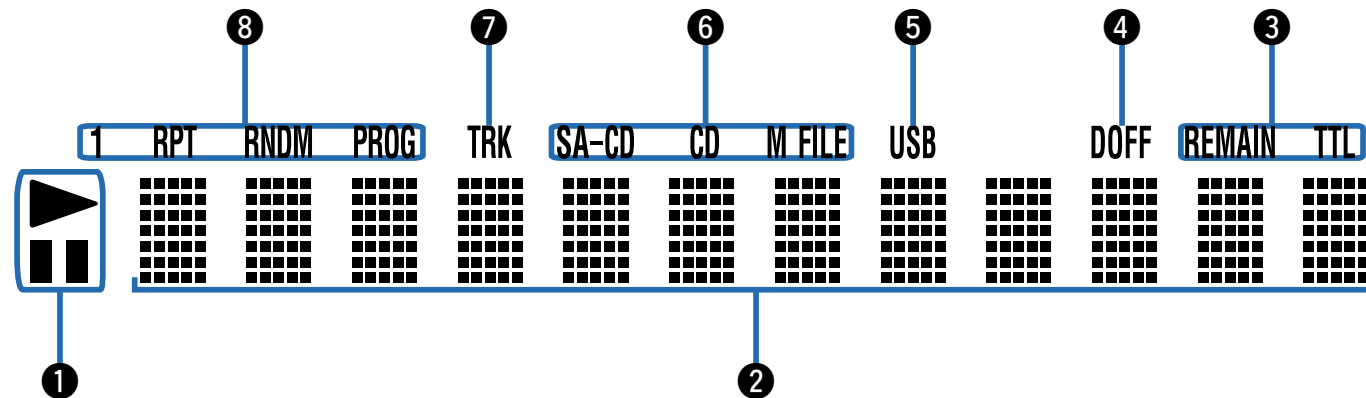

1 Playback mode indicators

▶ : Lights up during playback.

⏸ : Lights up during pause.

2 Information display

This area displays the time display and text information of the disc to be played, as well as the setting menu items, etc.

3 Time display indicators

REMAIN : This indicator lights up while the remaining track time is displayed.

TTL : This indicator lights up while the total remaining time.

4 Digital output off indicator (DOFF)

This indicator lights up when the digital output setting is set to off (🔧 page 55 "Digital Out").

5 USB indicator

This indicator lights up during operation in the USB mode.

6 Disc indicator

This indicator displays the disc type which is currently in the disc tray. "M FILE" lights up if the disc contains WMA/MP3 files.

7 TRK indicator

This indicator lights up above the display of the track number currently being played.

8 Special play mode indicator

1 : This indicator lights up during repeat play of one track.

RPT : This indicator lights up during repeat play.

RNDM : This indicator lights up during random play.

PROG : This indicator lights up during program play.



Rear panel

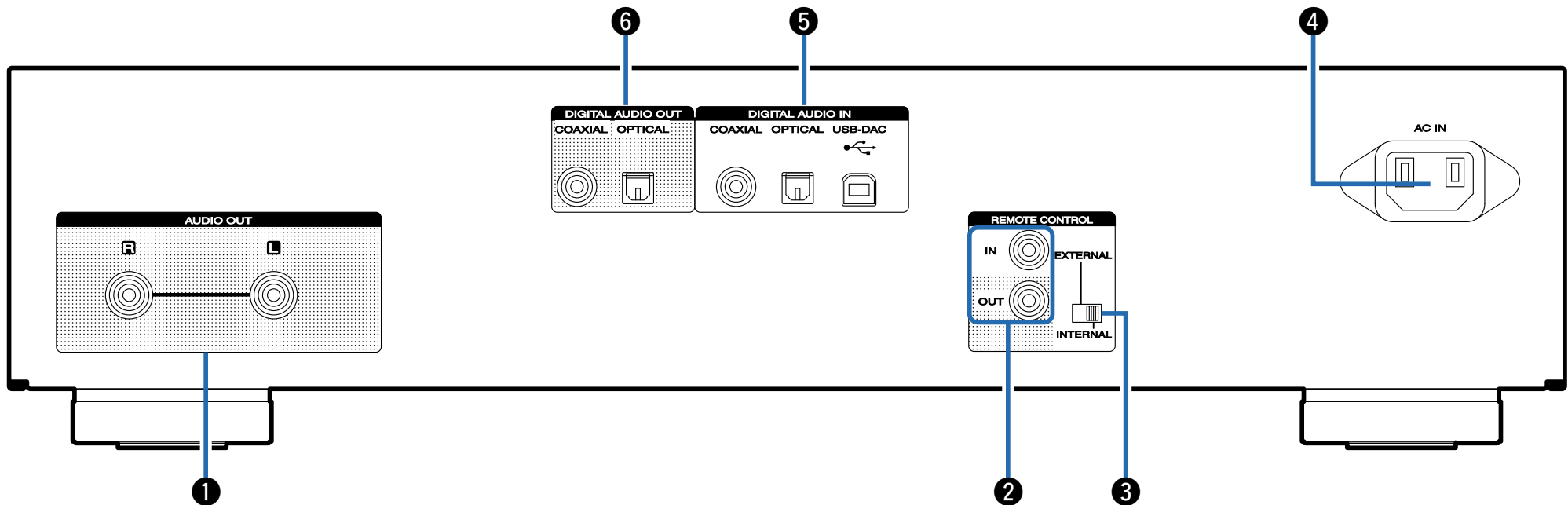

1 AUDIO OUT connectors

Used to connect devices equipped with analog audio inputs connectors or an external power amplifier ([page 18](#)).

2 REMOTE CONTROL IN/OUT connectors

Used to connect to a Marantz amplifier that is compatible with the remote control function ([page 24](#)).

3 EXTERNAL/INTERNAL switch

Turn this switch to "EXTERNAL" to operate the unit by pointing the remote control at the amplifier connected to this unit using the remote control connection ([page 24](#)).

4 AC inlet (AC IN)

Used to connect the power cord ([page 26](#)).

5 DIGITAL AUDIO IN connectors

Used to connect devices equipped with digital audio output connectors and PC ([page 20, 21](#)).

6 DIGITAL AUDIO OUT connectors

Used to connect an AV receiver or D/A converter equipped with digital audio input connectors ([page 19](#)).



Remote control unit

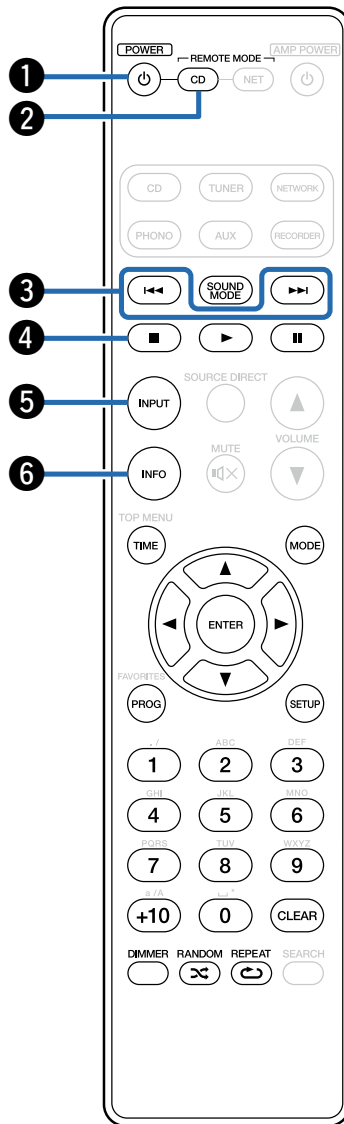

CD player operations

To operate CD player, press REMOTE MODE CD button to switch the remote control to the CD operation mode.

- REMOTE MODE CD button lights for approximately two seconds.

1 POWER button (⏻)

Turns power to this unit on and off (standby) (☞ page 28, 55).

2 Remote mode select button (REMOTE MODE CD)

This switches the remote control operating mode to CD.

3 Reverse-skip / Forward-skip buttons (⏮, ⏭)

Skip to previous track or next track. Press and hold to fast-forward/fast reverse (☞ page 32, 35, 39, 42).

4 Stop button (■)

Stop playback (☞ page 32, 35, 39, 42).

5 INPUT button

Used to select the playback media mode (☞ page 29).

6 Information button (INFO)

This switches the track information shown in the display during playback (☞ page 32, 36, 40, 43).



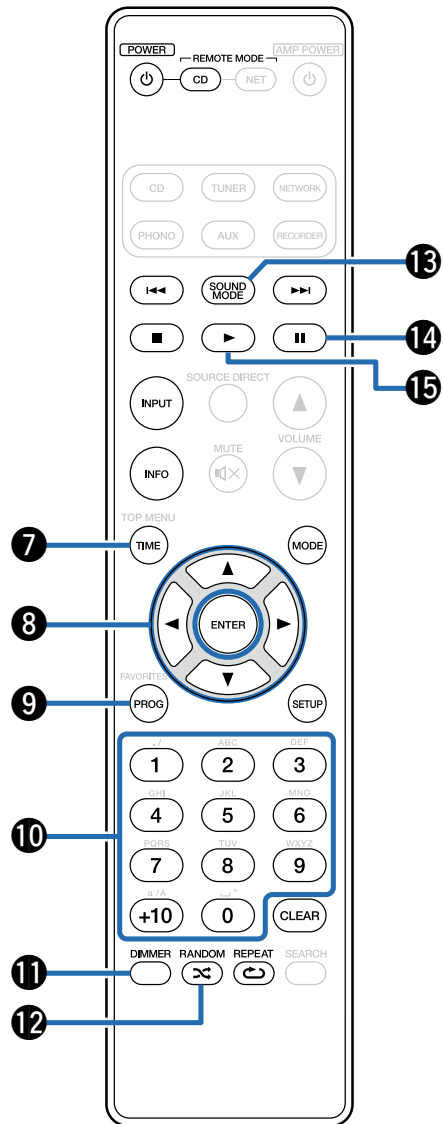

7 TIME button

This switches the playback time display (👉 page 32, 35, 39, 42).

8 Cursor buttons (▲▼◀▶)

These select items (👉 page 53).

9 Program button (PROG)

This sets program playback (👉 page 33).

10 Number buttons (0 – 9, +10)

These enter numbers into the unit (👉 page 32, 33).

11 DIMMER button

Adjust the display brightness of this unit (👉 page 29).

12 RANDOM button (🎲)

Switches the random playback (👉 page 32, 35, 39, 42).

13 SOUND MODE button

Switches the playback area or layer of the Super Audio CD (👉 page 30).

14 Pause button (⏸)

Pauses playback (👉 page 32, 35, 39, 42).

15 Play button (▶)

Starts playback (👉 page 32, 35, 39, 42).

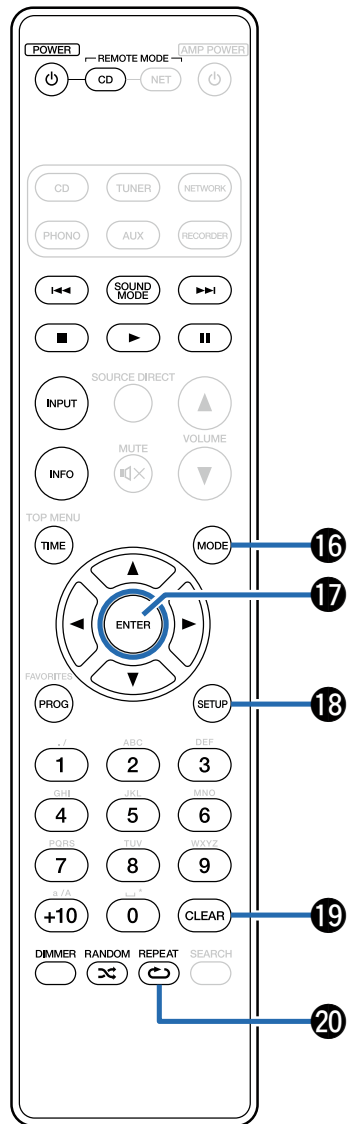

**16 MODE button**

This switches the playback mode (👉 page 34, 37, 42).

17 ENTER button

This determines the selection (👉 page 36, 37, 42, 53).

18 SETUP button

This displays the setting menu on the display (👉 page 53).

19 CLEAR button

This clears the program registration (👉 page 33).

20 REPEAT button (↺)

Switches the repeat playback (👉 page 32, 35, 39, 42).



- The amplifier can be operated with the amplifier operation buttons even when the remote control mode is CD.



Amplifier operations

The included remote control unit can be used to operate Marantz amplifiers.

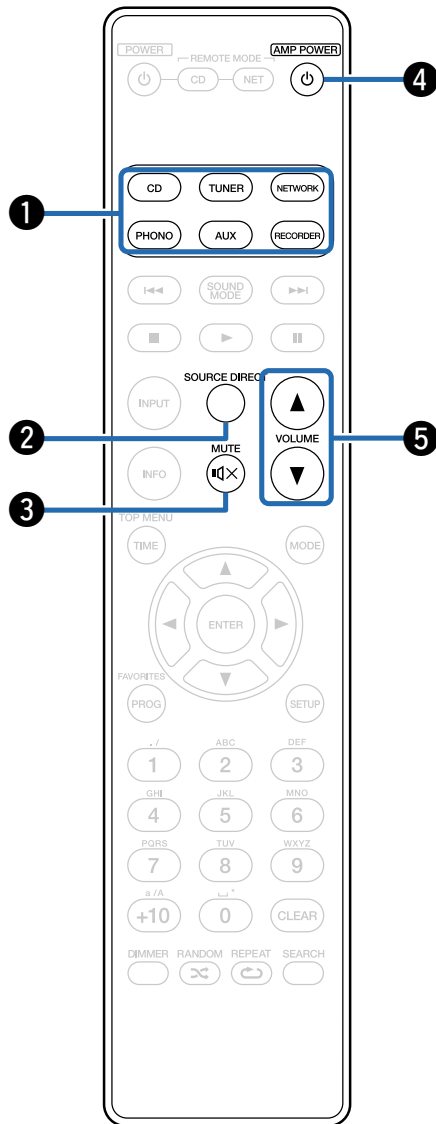

- 1** Input source select buttons
- 2** SOURCE DIRECT button
- 3** MUTE button (🔇)
- 4** AMP POWER button (🔌)
- 5** VOLUME buttons (▲▼)



Network audio player operations

To operate network audio player, press REMOTE MODE NET button to switch the remote control to the NETWORK operation mode.

- REMOTE MODE NET button lights for approximately two seconds.

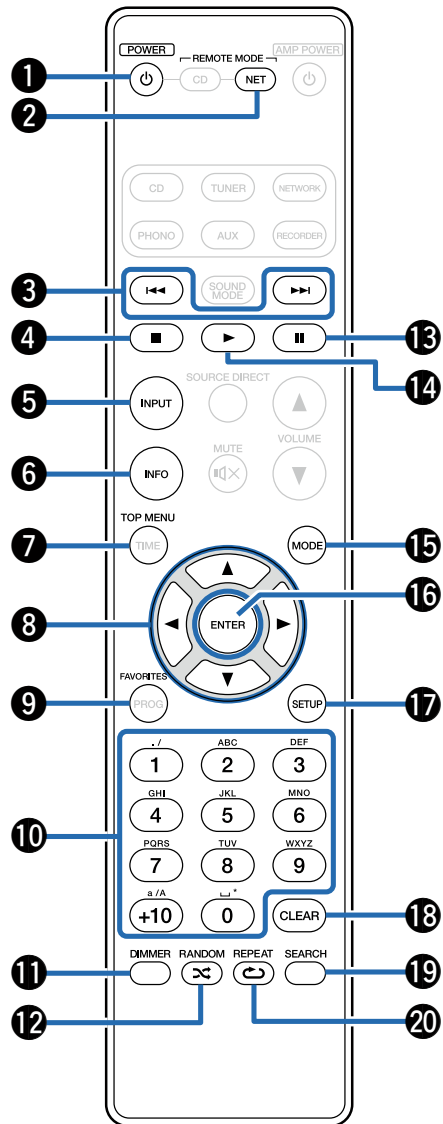

- ❶ POWER button (⏻)
- ❷ Remote mode select button (REMOTE MODE NET)
- ❸ Reverse-skip/Forward-skip buttons (I<<<, >>>I)
- ❹ Stop button (■)
- ❺ INPUT button
- ❻ Information button (INFO)
- ❼ TOP MENU button
- ❽ Cursor buttons (Δ, ∇, ◀, ▶)
- ❾ FAVORITES button
- ❿ Number buttons (0 – 9, +10)
- ⓫ DIMMER button
- ⓬ RANDOM button (∞)
- ⓭ Pause button (||)
- ⓮ Play button (▶)
- ⓯ MODE button
- ⓰ ENTER button
- ⓱ SETUP button
- ⓲ CLEAR button
- ⓳ SEARCH button
- ⓴ REPEAT button (↺)



- The amplifier can be operated with the amplifier operation buttons even when the remote control mode is NET.
- The included remote control unit can be used to operate Marantz network audio players.
- When using it, also refer to the operating instructions of the other devices.



Connections

Connecting an amplifier (👉 page 18)

Connecting a device equipped with digital audio input connectors (👉 page 19)

Connecting a device equipped with digital audio output connectors (👉 page 20)

Connecting a PC or Mac (👉 page 21)

Connecting an iPod or USB memory device to the USB port (👉 page 22)

Connecting the timer device (👉 page 25)





Connecting the power cord (👉 page 26)

NOTE

- Do not plug in the power cord until all connections have been completed.
- Do not bundle power cords together with connection cables. Doing so can result in humming or noise.

■ Cables used for connections

Provide necessary cables according to the devices you want to connect.

Audio cable (supplied)	
Remote connector cable (supplied)	
Optical cable (sold separately)	
Coaxial digital cable (sold separately)	
USB cable (sold separately)	



Connecting an amplifier

Use this connection for audio playback via an amplifier.

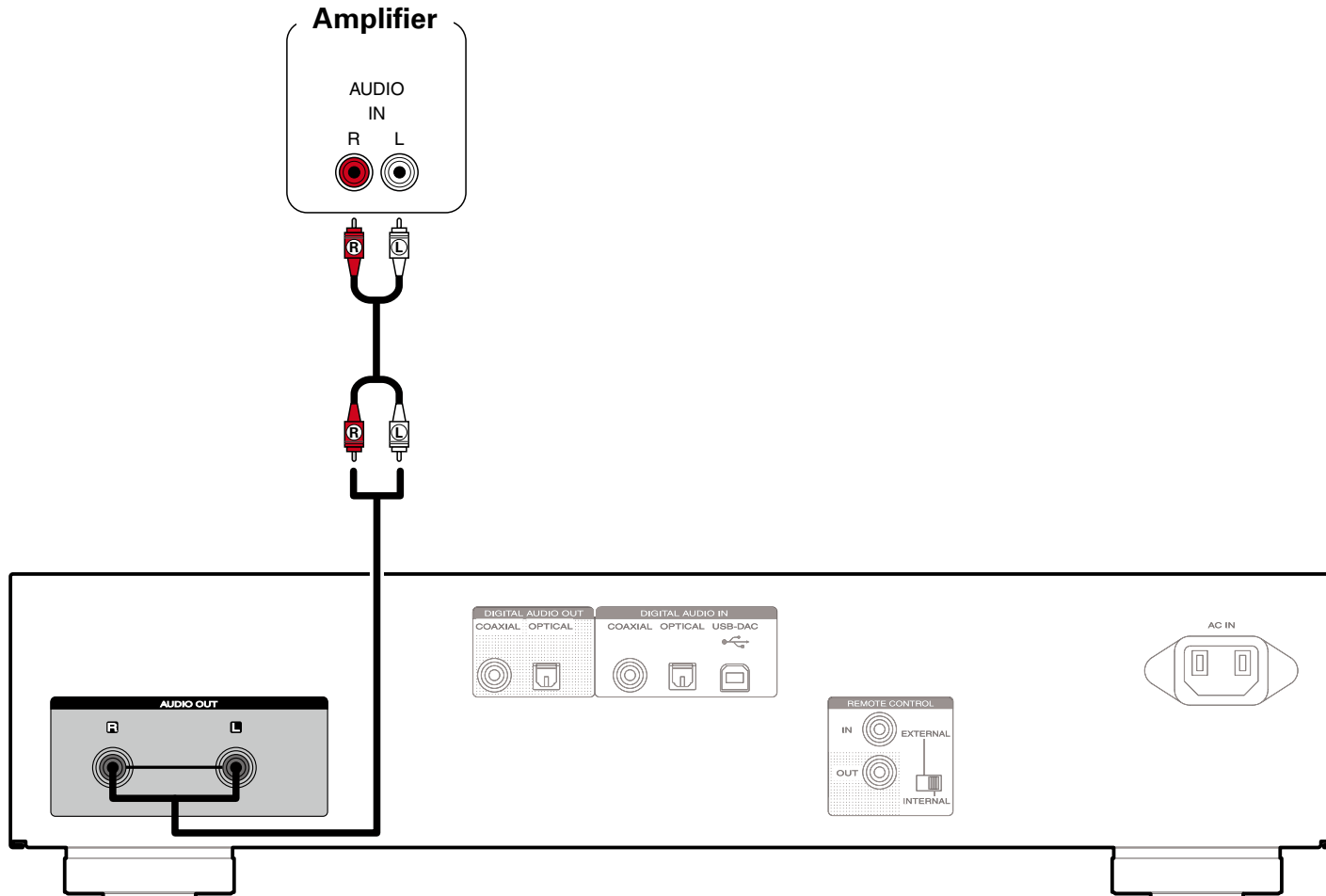

Connecting a device equipped with digital audio input connectors

Use this connection to output digital audio signals from this unit, and convert the signals for playback using the D/A converter of a connected device.

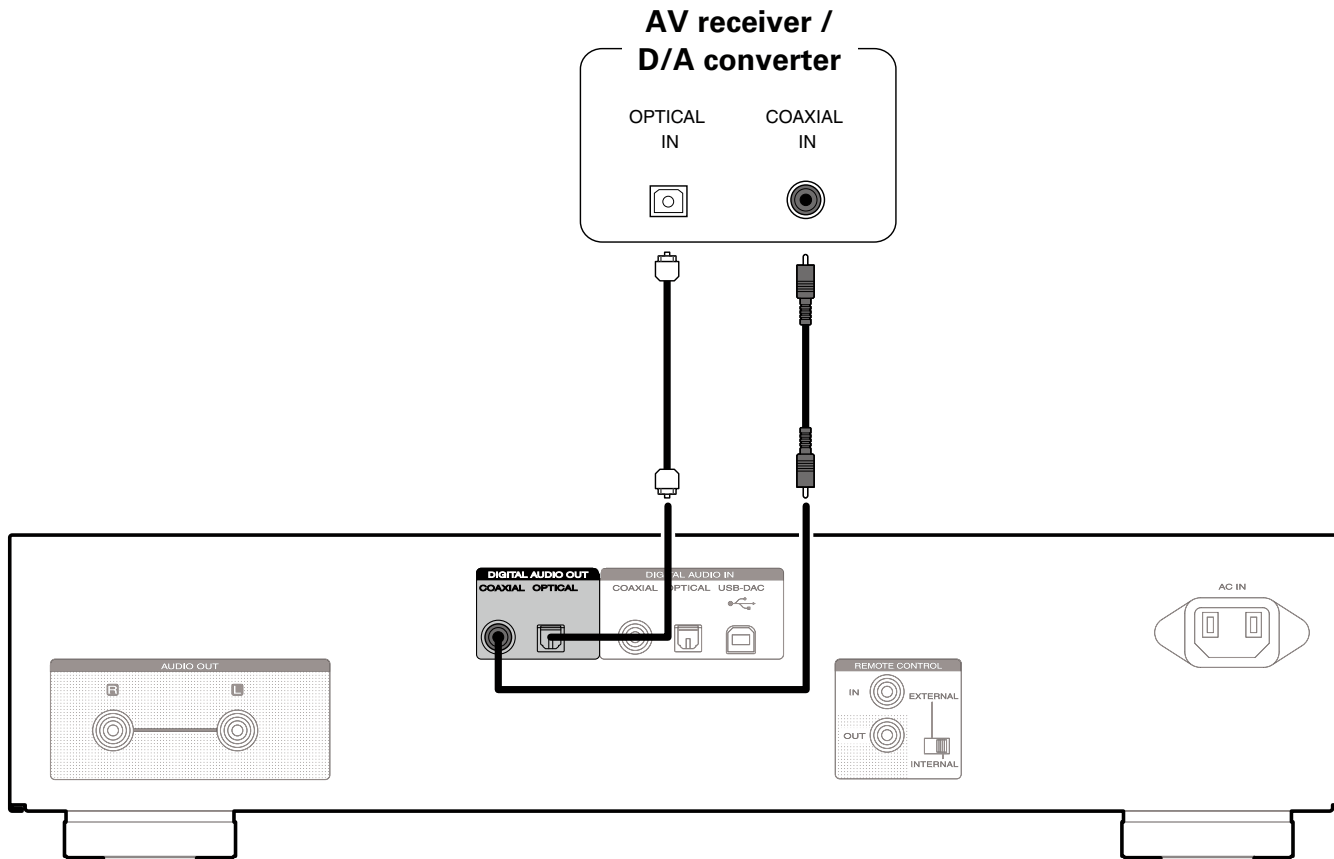

NOTE

- Signals that can be output using digital output are digital audio signals from the CD layer of the Super Audio CD, CD, USB (front), USB-DAC, COAXIAL, and OPTICAL.
- Digital audio output is stopped during playback of the HD layer of a Super Audio CD and USB-DAC (DSD signals and linear PCM signals that have a 32 kHz sampling frequency).



Connecting a device equipped with digital audio output connectors

Use this connection to input digital audio signals to this unit, and convert the signals for playback using the D/A converter of this unit (☞ page 44 "Using as a D/A converter").

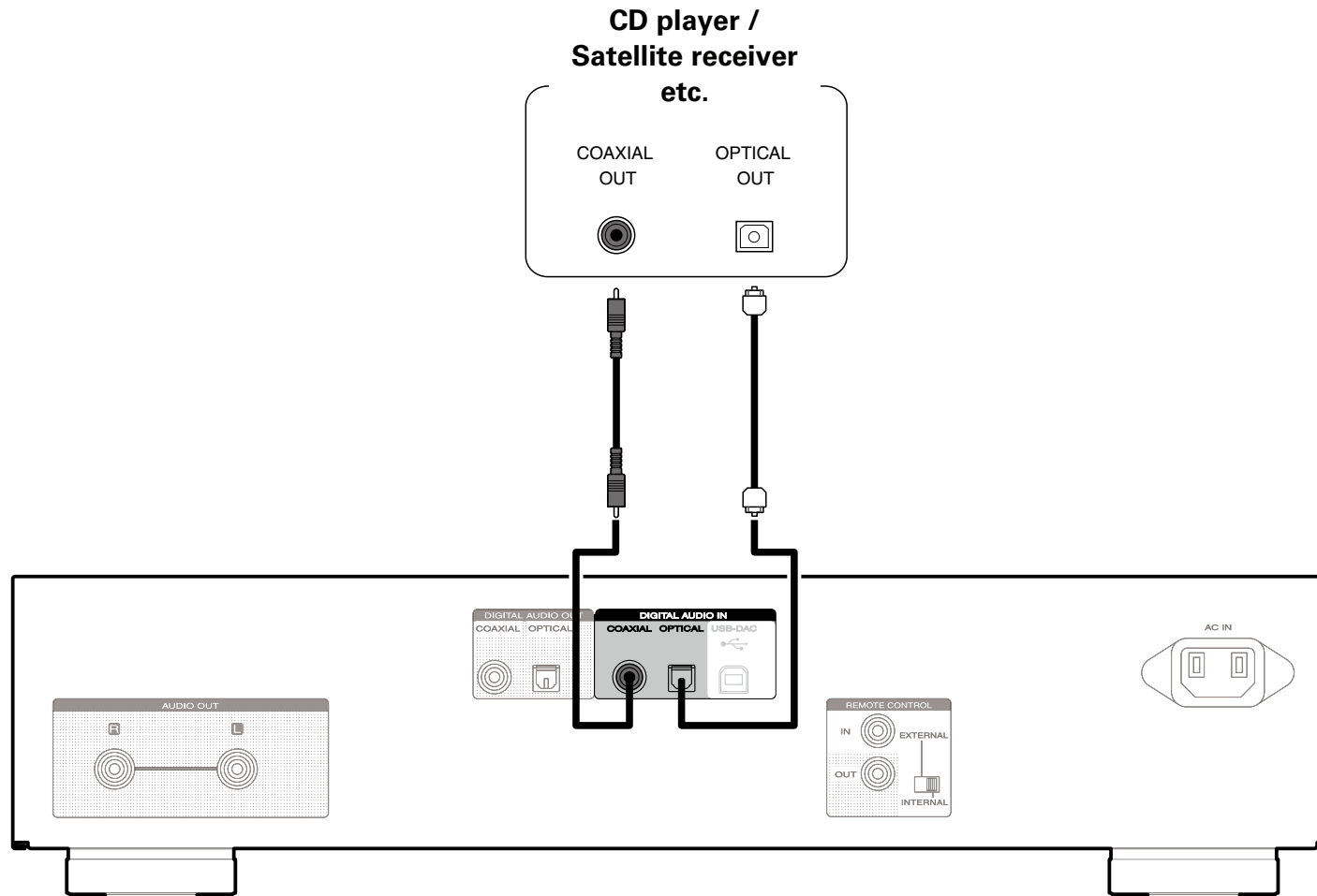

Connecting a PC or Mac

By connecting a computer to the USB-DAC port on the rear panel of this unit using a commercially available USB connecting cable, this unit can be used as a D/A converter (☞ page 44 “Using as a D/A converter”).

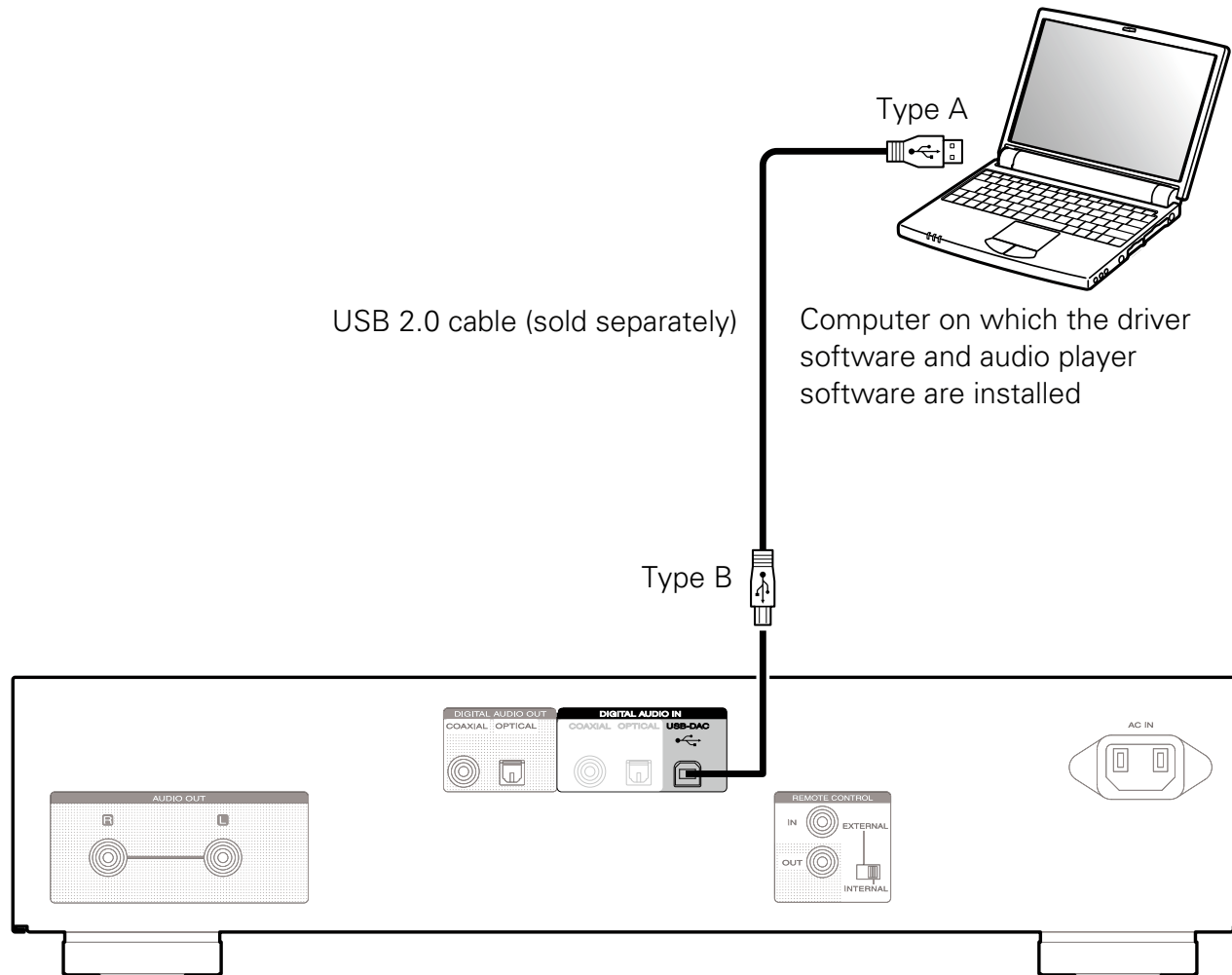

- Install the dedicated driver software on the computer to enable communication between the computer and this unit in order to playback high-resolution sound source (DSD signal or 192 kHz/24 bit PCM signal) audio available on the internet “Installing the dedicated driver (Windows OS only)” (☞ page 45).
- Download the driver software from the SA8005 page of the Marantz website.

NOTE

- Use a cable that is 3 m or less to connect to the computer.



Connecting an iPod or USB memory device to the USB port

To connect an iPod/iPhone to this unit, use the USB adapter cable that was supplied with the iPod/iPhone.

For operating instructions see “Playing an iPod” (page 37) or “Playing a USB memory device” (page 41).

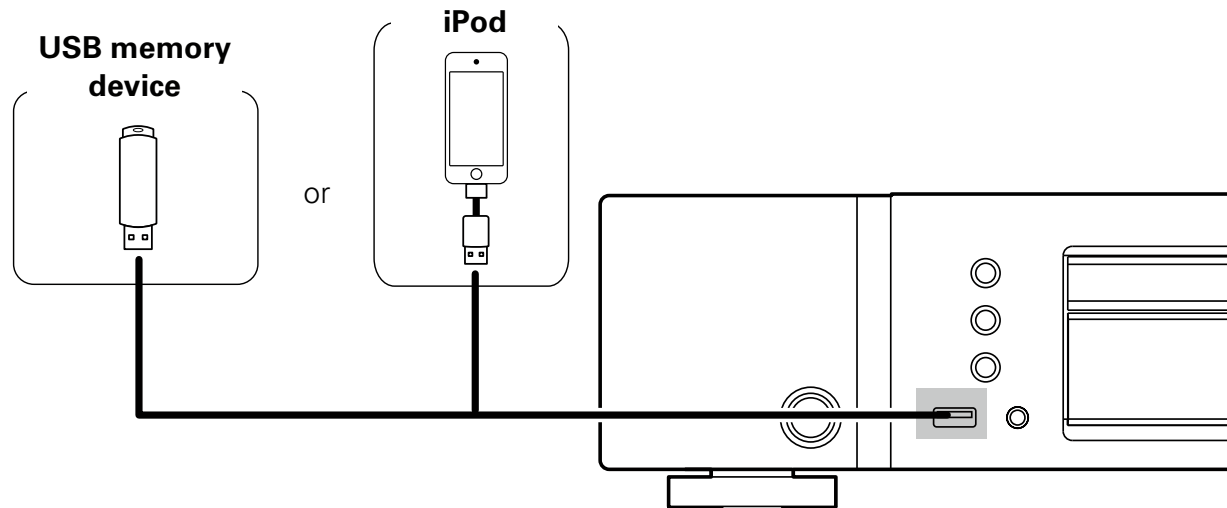

- Marantz does not guarantee that all USB memory devices will operate or receive power. When using a portable USB hard disk drive (HDD) which came with an AC adapter, use that device's supplied AC adapter.

NOTE

- USB memory devices will not work via a USB hub.
- It is not possible to use this unit by connecting the unit's USB port to a PC via a USB cable.
- Do not use an extension cable when connecting a USB memory device. This may cause radio interference with other devices.
- Connection to a computer is possible via the digital input USB-DAC port (Type B) on the rear panel. Playback is not possible when connected via the front panel's USB port.



■ Supported iPod/iPhone models

• iPod classic



iPod classic
80GB



iPod classic
160GB (2007)

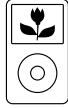

iPod classic
160GB (2009)

• iPod nano



iPod nano
3rd generation
(video)
4GB 8GB



iPod nano
4th generation (video)
8GB 16GB



iPod nano
5th generation (video camera)
8GB 16GB



iPod nano
6th generation
8GB 16GB



iPod nano
7th generation
16GB

• iPod touch

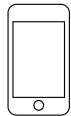

iPod touch
1st generation
8GB 16GB 32GB

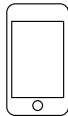

iPod touch
2nd generation
8GB 16GB 32GB



iPod touch
3rd generation
32GB 64GB



iPod touch
4th generation
8GB 32GB 64GB



iPod touch
5th generation
16GB 32GB 64GB

• iPhone

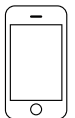

iPhone
4GB 8GB 16GB



iPhone 3G
8GB 16GB



iPhone 3GS
8GB 16GB 32GB

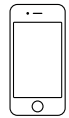

iPhone 4
8GB 16GB 32GB



iPhone 4S
16GB 32GB 64GB



iPhone 5
16GB 32GB 64GB



Remote control connection

When you use this unit connected to a Marantz amplifier, this unit receives operation signals sent from the amplifier and operates accordingly.

Connection

Use the supplied remote connector cable to connect the REMOTE CONTROL IN connector of this unit to REMOTE CONTROL OUT connector of the amplifier.

Setting

Turn the EXTERNAL/INTERNAL switch on the unit to "EXTERNAL".

- This setting will disable remote sensor reception of this unit.
- To operate the unit, point the remote control at the remote sensor of the amplifier.



- To use this unit by itself without connecting an amplifier, turn the switch to "INTERNAL".

This unit

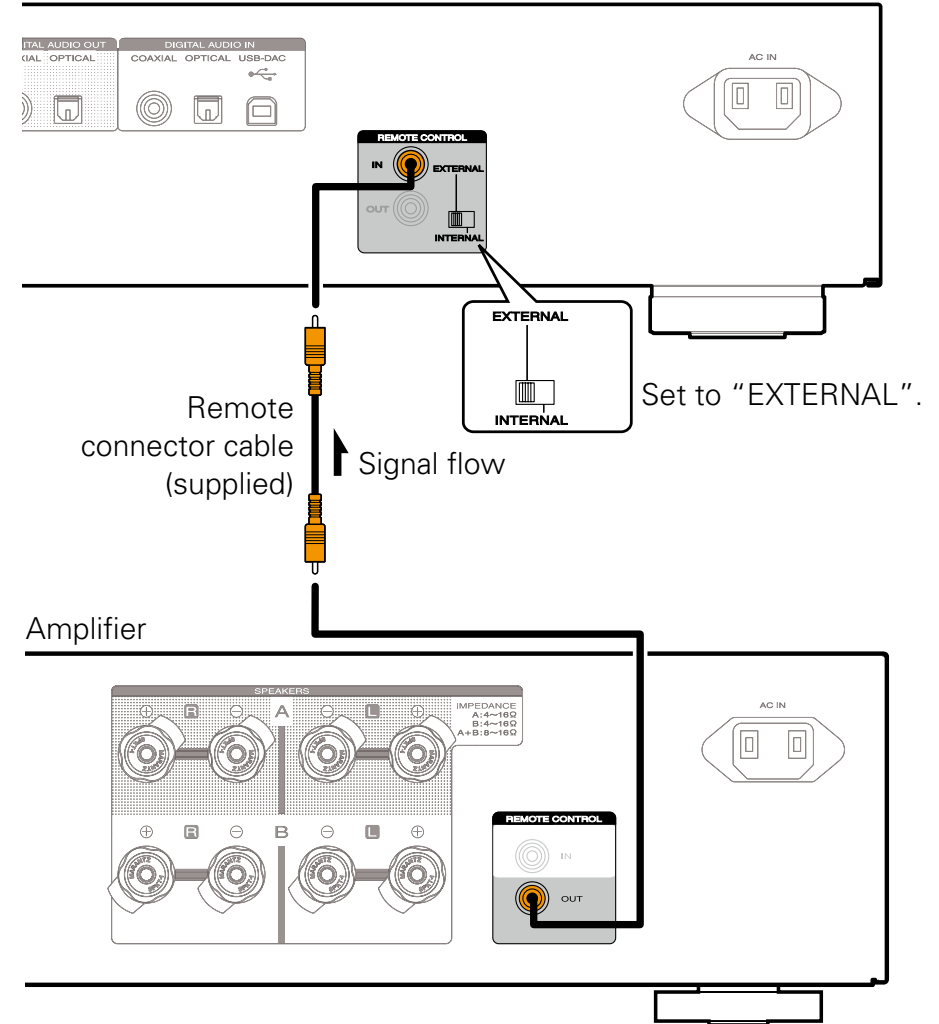

Connecting the timer device

By connecting this unit to an amplifier and timer device, you can use timer playback (☞ page 54 "Timer Play").

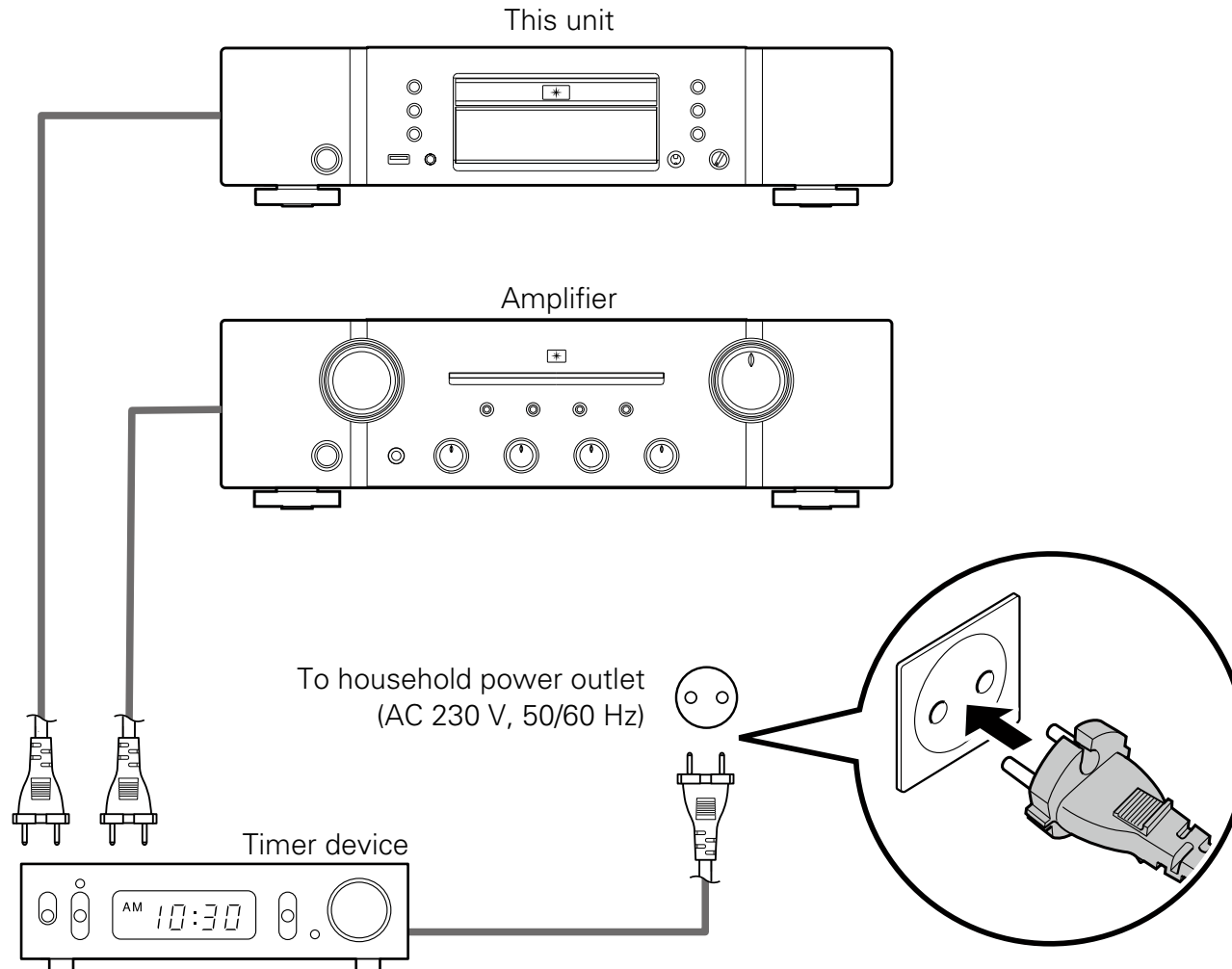

Connecting the power cord

After completing all the connections, insert the power plug into the power outlet.

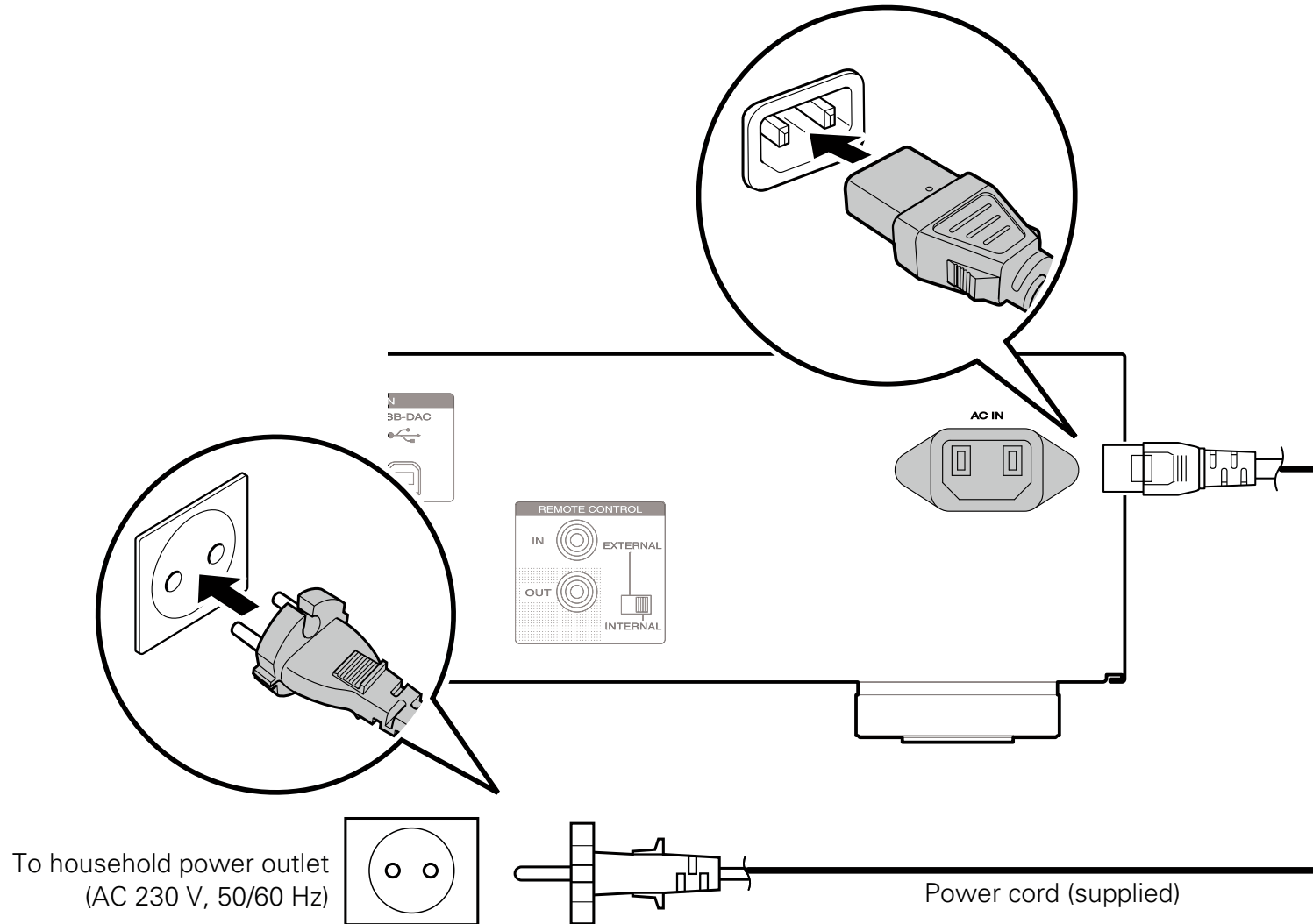

Playback

Turning the power on (👉 page 28)

Select the playback media mode (👉 page 29)

Switching the display's brightness (👉 page 29)

Stopping digital outputs (👉 page 29)

Setting the top priority playback layer for Super Audio CDs (👉 page 30)

Playing CDs/Super Audio CDs (👉 page 31)

Playing DATA CDs (👉 page 34)

Playing an iPod (👉 page 37)

Playing a USB memory device (👉 page 41)

Using as a D/A converter (👉 page 44)

Connecting and playing back from a computer (USB-DAC) (👉 page 45)

Connect and playback from a digital device (Coaxial/Optical) (👉 page 51)



Basic operation

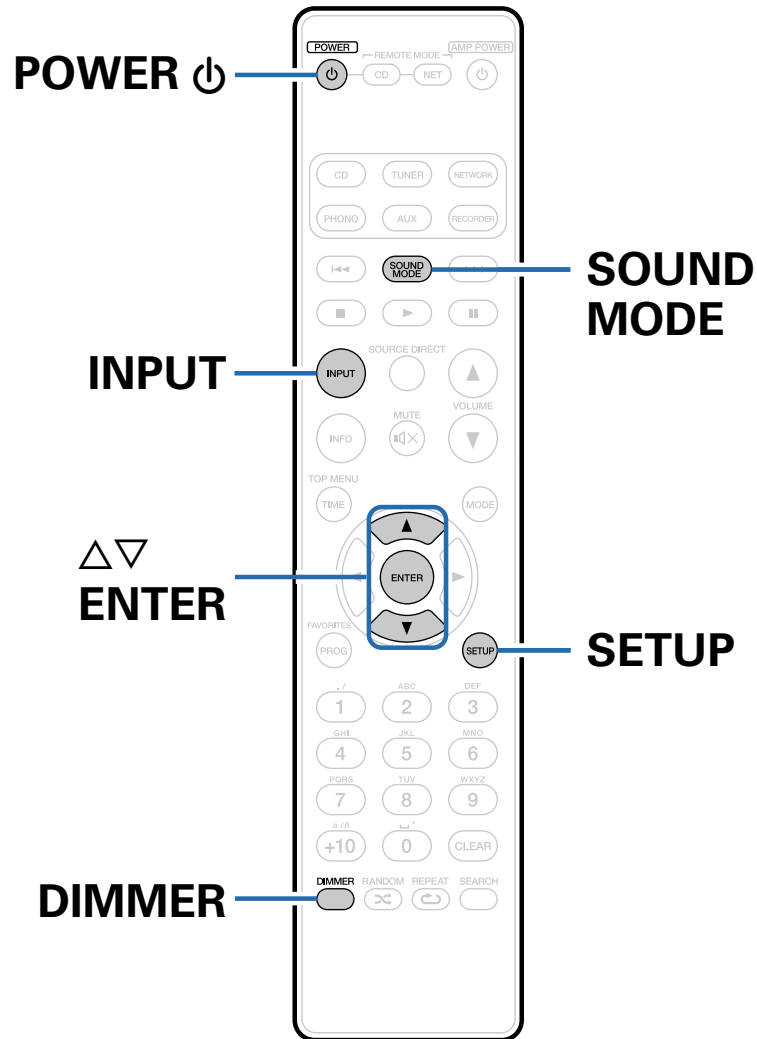

Turning the power on

- 1 Press **POWER** to turn on power to the unit.
The power indicator turns off.



- You can also press on the main unit to turn the power on.

Switching the power to standby

- 1 Press **POWER** .
- The unit switches to standby mode, and the Power indicator lights red.

NOTE

- Power continues to be supplied to some of the circuitry even when the power is in the standby mode. When leaving home for long periods of time or when going on vacation, unplug the power cord from the power outlet.



Select the playback media mode

1 Press INPUT to select the playback media mode.

Disc : Select to playback a disc.

USB : Select to playback an iPod or USB memory device.

USB-DAC / Coaxial / Optical :

Select to use this unit as a D/A converter.



- You can also select the media mode by pressing DISC/INPUT on the main unit.

Switching the display's brightness

The display brightness can be adjusted between four levels. Switching the display off reduces a source of noise that affects sound quality, enabling higher sound quality playback.

1 Press DIMMER.



- When the display is turned off, the DISPLAY OFF indicator lights.

NOTE

- During stop mode, the display information does not turn off. The information is turned off only during playback.

Stopping digital outputs

Stopping digital audio output reduces a source of noise that affects sound quality, enabling higher sound quality playback.

1 During stop mode, press SETUP.

2 Use Δ / ∇ to select "Digital Out", and press ENTER.

3 Use Δ / ∇ to select "Off", and press ENTER.

On (Default) : Outputs the digital signal.

Off : Digital signal is not output.



- When digital output is turned off, the "DOFF" indicator lights up on the display.
- The "Digital Out" has a memory retention function where the settings remain stored and unchanged even when the disc is changed or the power is turned off.



Setting the top priority playback layer for Super Audio CDs

The layer that is played with priority when the disc is loaded can be set.

- 1 Press INPUT to select the playback media mode to "Disc".**
- 2 Check that no disc is loaded.**
 - If the layer is switched while the disc is being loaded, the playback layer switches for that disc, but the top priority playback layer setting itself does not change.
- 3 Press SOUND MODE and switch to the layer you want to set.**

STEREO (Default) : Plays back the 2-channel area of the Super Audio CD.

MULTI : Plays back the multi-channel area of the Super Audio CD. The analog output of this unit outputs a down-mixed 2-channel signal.

CD : Plays back the CD layer of the Super Audio CD.



- When a disc is loaded after the setting has been made, the contents recorded on the set layer are displayed.
- If a disc that does not contain the layer set for top priority playback is loaded, the contents recorded on another layer are displayed automatically.
- This setting is stored in the memory and is not cleared even when the disc holder is opened or closed or the power is turned off. To change the setting, repeat the procedure above.
- The priority playback layer cannot be set when a disc is inserted or "Open" is shown on the display.
- If the area and layer have not been set for a disc, the priority playback order is as follows:

① STEREO ② MULTI ③ CD







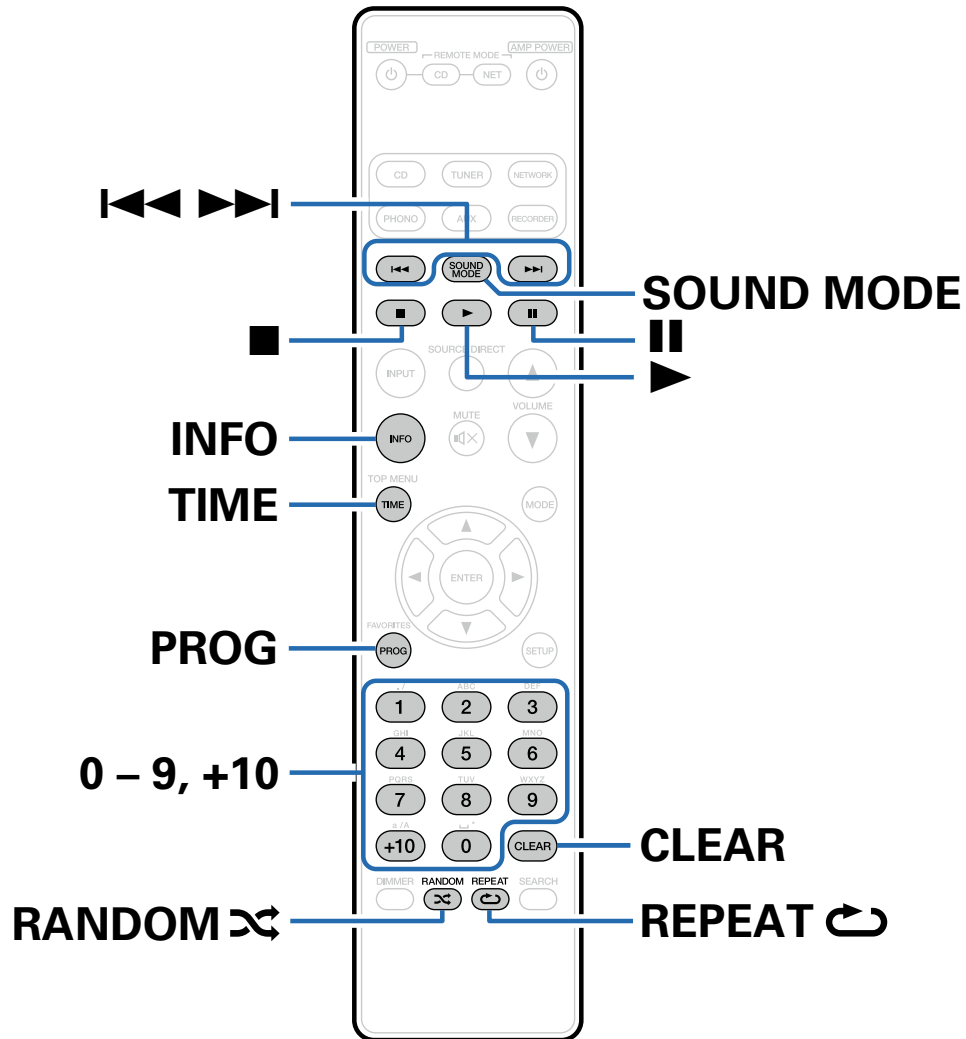

Playing CDs/Super Audio CDs

Playing CDs and Super Audio CDs

- 1 Insert a disc (👉 page 69).**
 - Press ▲ on the unit to open/close the disc tray.
- 2 When playing back a Super Audio CD, press SOUND MODE to set the playback layer (👉 page 30).**
- 3 Press ▶.**
 - The ▶ indicator lights on the display.
 - Playback starts.



Operation buttons	Function
	Playback
	Pause
	Stop
	Skip to previous track / Skip to next track (Press and hold) Fast-reverse / Fast-forward
0 – 9, +10	Select the track
RANDOM 	Random playback <ul style="list-style-type: none"> • Can be set during stop.
REPEAT 	Repeat playback <ul style="list-style-type: none"> • Switching between Single-track repeat and All-track repeat.
TIME	Time display switching <ul style="list-style-type: none"> • Switching between elapsed time of the current track, remaining time of the current track and remaining time of all tracks.
INFO	Text information display <ul style="list-style-type: none"> • Text information recorded on the media is displayed.

NOTE

- Do not place any foreign objects in the disc tray. Doing so could damage it.
- Do not push the disc tray in by hand when the power is turned off. Doing so could damage the set.

■ Discs that can be played back

See “Discs” ( page 64).

■ Playing a specific track (Direct search)

1 Use 0 – 9 and +10 to select the tracks.

[Example]

Track 4 : Press number 4 to select track 4.

Track 12 : Press numbers +10 and 2 consecutively to select track 12.

■ Switching the display

Press INFO.

Displays text information stored on media.

- The display content varies according to the media. (The text information is only displayed for Super Audio CD.)
- The player can display the following characters :

ABCDEFGHIJKLMNOPQRSTUVWXYZ

abcdefghijklmnopqrstuvwxyz

0123456789

! " # \$ % & ; : ; < > ? @ \ [] _ ` | { } ~ ^ ' () * + , - . / = (space)



Playing tracks in a specific order (Program playback)

Up to 20 tracks can be programmed.

- 1 In the stop mode, press PROG.**
"PROG" is displayed on the display.
- 2 Use 0 – 9 and +10 to select the tracks you want to program.**
[Example]
To program tracks 3 and 12 to be played in that order, press 3, +10, and 2 one after the other.
- 3 Press ►.**
Playback starts in the programmed order.



- When REPEAT  is pressed during program playback, the tracks are played repeatedly in the programmed order.

NOTE

- The program is cleared when the disc tray is opened or the power is turned off.

■ Checking the order of the programmed tracks

In the stop mode, press ►►I.

The track numbers are displayed in the programmed order each time the button is pressed.

■ To clear the last track programmed

In the stop mode, press CLEAR.

The last track programmed is cleared each time the button is pressed.

■ Clearing the all programmed track

In the stop mode, press PROG.



Playing DATA CDs

- This section explains how to playback MP3 and WMA files that are recorded onto a CD-R or CD-RW.
- There are many music distribution sites on the Internet allowing you to download music files in MP3 or WMA (Windows Media® Audio) format. The music (files) downloaded from such sites can be stored on CD-R or CD-RW discs and played on this unit.

“Windows Media” and “Windows” are registered trademarks or trademarks in the United States and other countries of Microsoft Corporation of the United States.

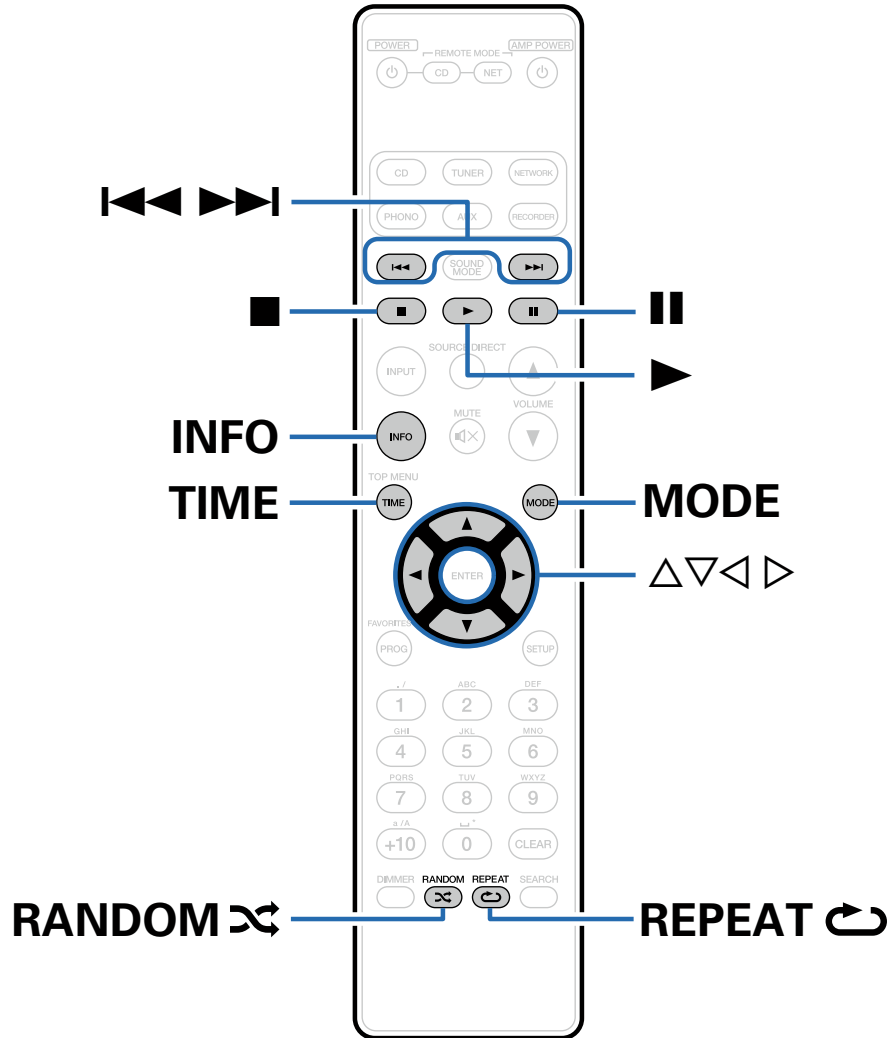

Playing files

1 Load a CD-R or CD-RW disc containing music files in the MP3 or WMA formats into the disc tray (👉 page 69).

- Press ▲ on the unit to open/close the disc tray.

2 Press MODE to select “Folder” or “All Files”.

❑ About the display

• When “Folder” is selected

All the files in the selected folder are played.

• When “All Files” is selected

After the selected folder and files are played, all the files in all the folders are played.

3 Use △▽ to select the folder to be played.

4 Use ◀▶ to select the file to be played.

5 Press ▶.

Playback starts.

Operation buttons	Function
▶	Playback
⏸	Pause
■	Stop
⏮ ⏭	Skip to previous track / Skip to next track (Press and hold) Fast-reverse / Fast-forward
△▽	Folder select
◀▶	File select
MODE	Switch to Folder playback mode <ul style="list-style-type: none"> • Playing back only within the selected folder.
RANDOM 🎲	Random playback <ul style="list-style-type: none"> • During random playback, the playback range becomes “All Files”. • Can be set during stop.
REPEAT ↺	Repeat playback <ul style="list-style-type: none"> • Switching between Single-track repeat and All-track repeat.
TIME	Time display switching <ul style="list-style-type: none"> • Switching between elapsed time of the current track, remaining time of the current track and remaining time of all tracks.
INFO	Text information display <ul style="list-style-type: none"> • Text information recorded on the media is displayed.





- The folder and file numbers are set automatically when the disc is loaded.

NOTE

- Programmed playback is not possible with MP3/WMA discs.
- Copyright-protected files cannot be played.
Note that depending on the software used for burning and other conditions, some files may not play or display correctly.

Files that can be played back

See "DATA CD" ( page 65).

To switch the folder or file during playback

- **Folder**

Use $\Delta \nabla$ to select the folder.

- **File**

Use $\triangleleft \triangleright$ to select the file.

Also use $\blacktriangleleft\blacktriangleleft$, $\blacktriangleright\blacktriangleright$ to select the file.

- The file numbers are set automatically when the disc is loaded.

Switching the display

During playback, press INFO.

- Switching between the folder name and file name.
- Folder and file names can be displayed as titles. Up to 11 alphanumeric characters and underscores can be displayed. Characters which cannot be displayed appear as asterisks.
- The player can display the following characters:

ABCDEFGHIJKLMNOPQRSTUVWXYZ

abcdefghijklmnopqrstuvwxyz

0123456789

! " # \$ % & ; : ; < > ? @ \ [] _ ` | { } ~ ^ ' () * + , - . / = (space)



Playing an iPod

- You can use the USB cable provided with the iPod to connect the iPod with the unit's USB port and enjoy music stored on the iPod.
- For information on the iPod models that can be played back with this unit, see "Supported iPod/iPhone models" (page 23).



"Made for iPod" and "Made for iPhone" mean that an electronic accessory has been designed to connect specifically to iPod or iPhone, respectively, and has been certified by the developer to meet Apple performance standards.

Apple is not responsible for the operation of this device or its compliance with safety and regulatory standards. Please note that the use of this accessory with iPod or iPhone may affect wireless performance. iPhone, iPod, iPod classic, iPod nano, iPod shuffle, and iPod touch are trademarks of Apple Inc., registered in the U.S. and other countries.

- Individual users are permitted to use iPhone, iPod, iPod classic, iPod nano, iPod shuffle, and iPod touch for private copy and playback of non-copyrighted contents and contents whose copy and playback is permitted by law. Copyright infringement is prohibited by law.

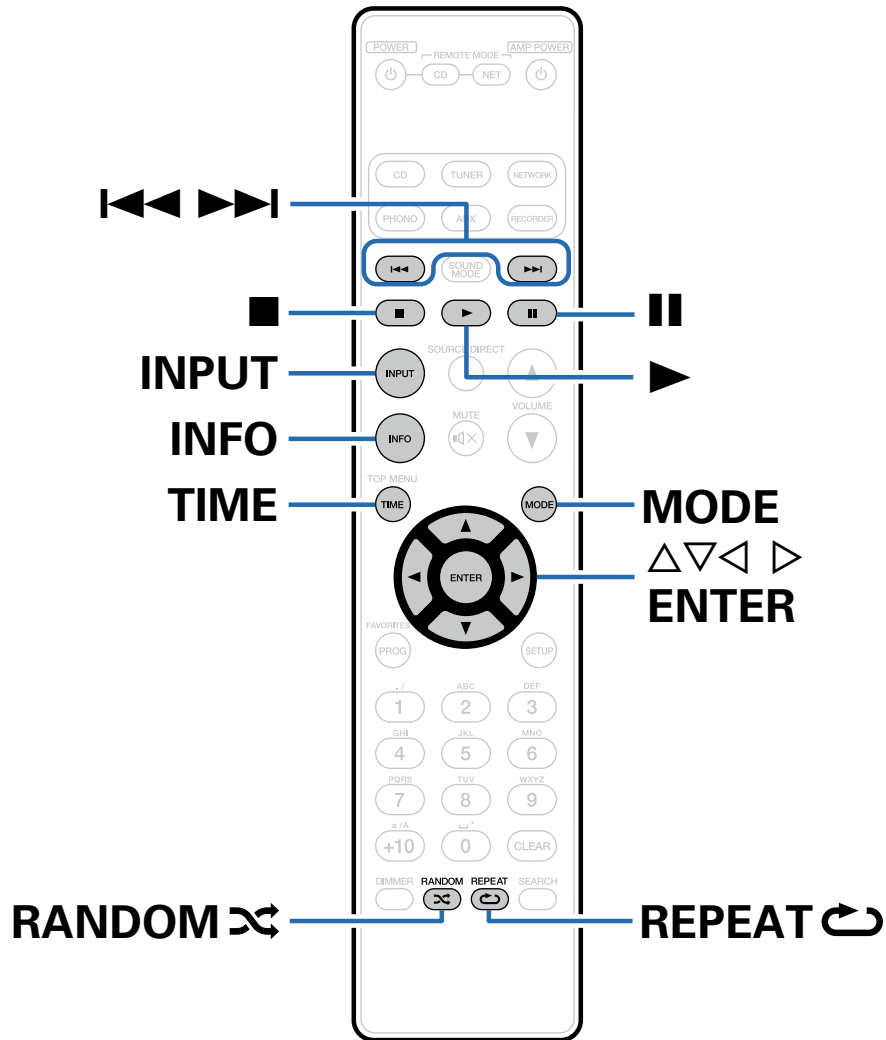

Listening to music on an iPod

- 1 Press INPUT to select the playback media mode to "USB" (👉 page 29).**
- 2 Connect the iPod to the USB port (👉 page 22).**
"Direct iPod" is displayed on the display of this unit.
- 3 Operate iPod itself directly while seeing the iPod screen to play back music.**



- The iPod display modes include "Direct iPod" and "Remote iPod".
By default, "Direct iPod", where you directly operate the iPod itself while looking at the iPod screen, is set.

NOTE

- Depending on the type of iPod and the software version, some functions may not operate.
- Note that Marantz will accept no responsibility whatsoever for any problems arising with the data on an iPod when using this unit in conjunction with the iPod.



Setting operation mode (Remote iPod mode)

In this mode, various lists and screens during playback on the iPod are displayed on the body.







This section describes the steps up to playing back tracks on the iPod in "Remote iPod".

1 Press MODE and display "Remote iPod".

Display mode		Direct iPod	Remote iPod
Playable files	Music file	✓	✓
	Video file	*	
Active buttons	Remote control unit (This unit)	✓	✓
	iPod	✓	

* Only the sound is played.

2 Use $\Delta \nabla$ to select the file to be played, then press ENTER. Playback starts.

Operation buttons	Function
	Playback
	Pause
	Stop
	Skip to previous track / Skip to next track (Press and hold) Fast-reverse / Fast-forward
RANDOM 	Random playback
REPEAT 	Repeat playback • Switching between Single-track repeat and All-track repeat.
MODE	Switching between "Remote iPod" and "Direct iPod"
TIME	Time display switching • Switching between elapsed time of the current track, remaining time of the current track and remaining time of all tracks.
INFO	Text information display • Text information recorded on the media is displayed.
$\Delta \nabla \triangleleft \triangleright$	Select the item



NOTE

- Marantz will accept no responsibility whatsoever for any loss of iPod data.
- Depending on the type of iPod and the software version, some functions may not operate.

■ Switching the display

During playback, press INFO.

- Switching between the title name, artist name and album name.



Playing a USB memory device

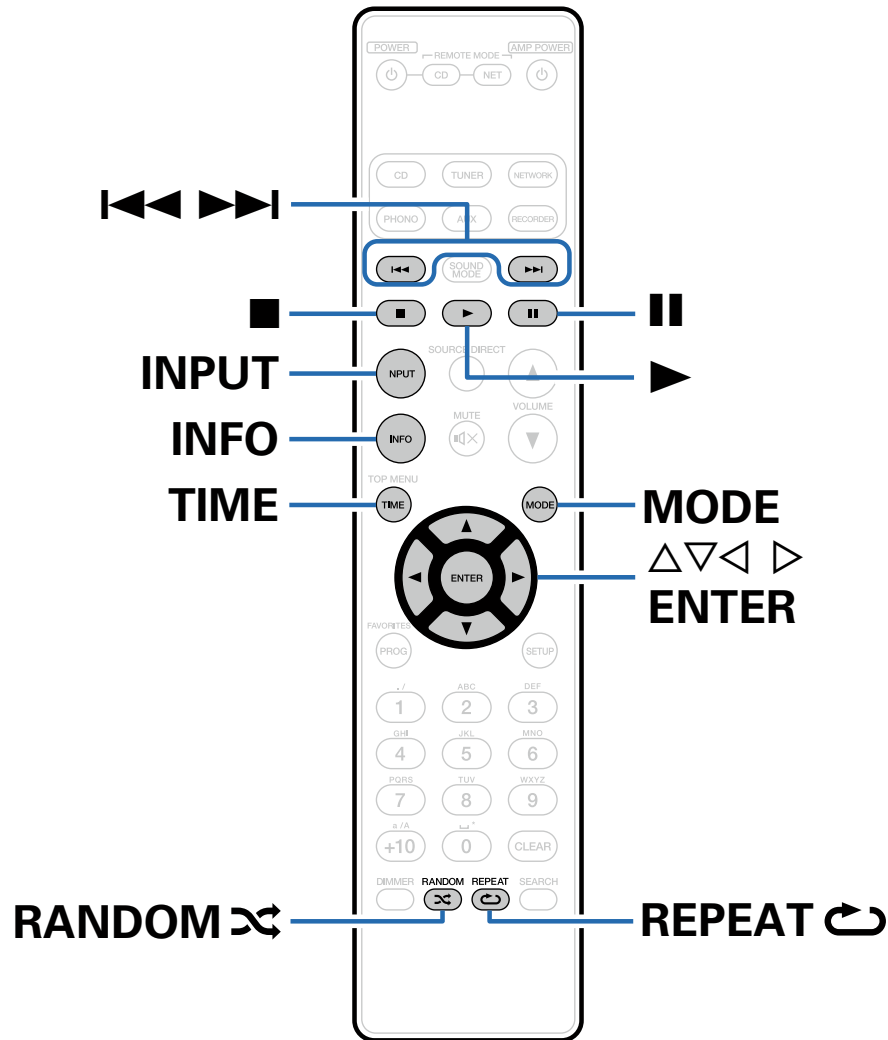







- Playing back music files stored on a USB memory device.
- Only USB memory devices conforming to mass storage class can be played on this unit.
- This unit is compatible with USB memory devices in “FAT16” or “FAT32” format.
- This unit can play back the following files.
 - **WMA** (Windows Media Audio)
 - **MP3** (MPEG-1 Audio Layer-3)
 - **WAV**
 - **AAC** (Advanced Audio Codec)



Playing files stored on USB memory device

- 1** Press **INPUT** to select the playback media mode to "USB" (👉 page 29).
- 2** Connect the USB memory device to the USB port (👉 page 22).
- 3** Press **MODE** to select the "Folder" or "All Files".
 - ❑ **About the display**
 - **When "Folder" is selected**
All the files in the selected folder are played.
 - **When "All Files" is selected**
After the selected folder and files are played, all the files in all the folders are played.
- 4** Use $\Delta \nabla$ to select the folder, then press **ENTER**.
- 5** Use $\Delta \nabla$ to select the file, then press **ENTER**.
Playback starts.

Operation buttons	Function
	Playback
	Pause
	Stop
	Skip to previous track / Skip to next track (Press and hold) Fast-reverse / Fast-forward
RANDOM 	Random playback
REPEAT 	Repeat playback • Switching between Single-track repeat and All-track repeat.
MODE	Switch to Folder playback mode • Switching between "Folder" and "All Files".
TIME	Time display switching • Switching between elapsed time of the current track, remaining time of the current track and remaining time of all tracks.
INFO	Text information display • Text information recorded on the media is displayed.
$\Delta \nabla \triangleleft \triangleright$	Select the item





- When “USB Resume” (🔗 page 55) is set to “On” in the menu, this unit performs the following operations.
 - When the media mode is set to “USB” and a USB memory device is connected to this unit, playback starts automatically.
 - When the media mode is switched to “USB” while a USB memory device is connected to this unit, playback starts automatically.

NOTE

- Note that Marantz will accept no responsibility whatsoever for any problems arising with the data on a USB memory device when using this unit in conjunction with the USB memory device.

Files that can be played back

See “USB memory device” (🔗 page 65).

Switching the display

During playback, press INFO.

- Switching between the title name, artist name and album name.
- While a WAV file is being played back, only the file name is displayed.
- The player can display the following characters:

ABCDEFGHIJKLMNOPQRSTUVWXYZ

abcdefghijklmnopqrstuvwxyz

0123456789

! " # \$ % & ; : < > ? @ \ [] _ ` | { } ~ ^ ' () * + , - . / = (space)



Using as a D/A converter

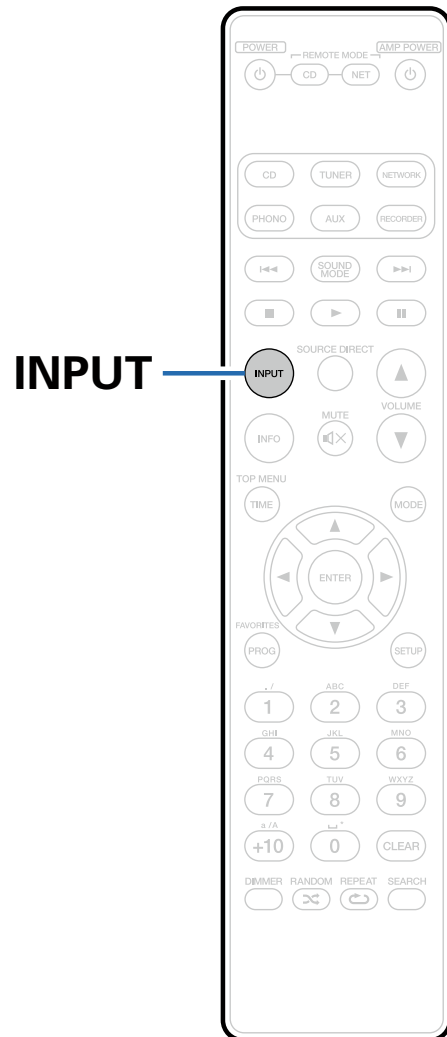

Digital audio signals input from an external device or computer into this unit can be converted and output as analog signals using this unit (D/A converter).

- DSD is a registered trademark.
- Microsoft, Windows XP, Windows Vista, Windows 7 and Windows 8 are either registered trademarks or trademarks of Microsoft Corporation in the United States and/or other countries.
- Apple, Macintosh and Mac OS are trademarks of Apple Inc., registered in the U.S. and other countries.



Connecting and playing back from a computer (USB-DAC)

- You can enjoy high-quality audio playback from the D/A converter built in to this unit by inputting PCM signal or DSD signal music files into this unit from a computer via USB connection.
- In order to use USB-DAC playback, install the dedicated driver onto your computer to enable your computer and this unit to communicate.
- Drivers do not need to be installed for Mac OS.
- Also, you can use whichever commercially available or downloadable player software you like to playback files on your computer.

■ Computer (recommended system)

OS

- Windows® XP Service Pack3, Windows® Vista, Windows 7 or Windows 8
- Mac OS X 10.6.3 or later.

USB

- USB 2.0: USB High speed/USB Audio Class Ver.2.0

■ Installing the dedicated driver (Windows OS only)

□ Installing the driver software

- 1 Disconnect the USB cable between your computer and the unit.**
 - The driver software cannot be installed correctly if your computer is connected to the unit by a USB cable.
 - If the unit and your computer are connected by a USB cable and the computer is switched on before installation, disconnect the USB and restart the computer.
- 2 Download the dedicated driver from the “Download” section of the SA8005 page of the Marantz website onto your computer.**
- 3 Unzip the downloaded file, select the 32-bit or 64-bit exe file that matches your Windows operating system, and double-click the file.**



4 Install the driver.

- ① Select the language to use for the installation.
- ② Click "OK".



- ③ The wizard menu is displayed. Click "Next".

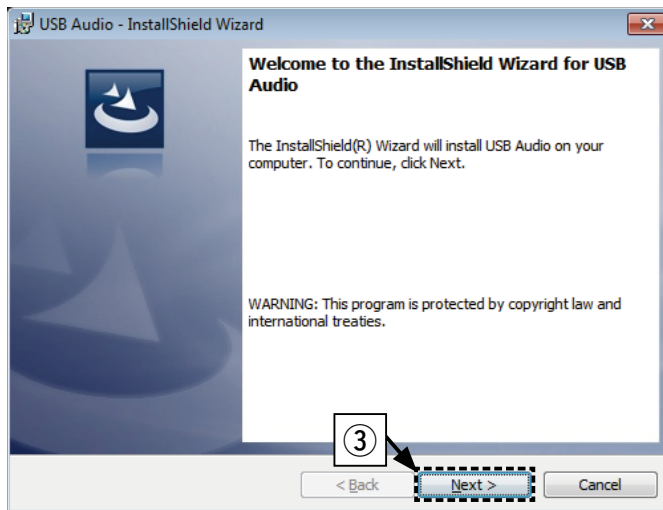

- ④ Read the Software Licensing Agreement, and click "I accept the terms in the license agreement".
- ⑤ Click "Next".



- ⑥ Click “Install” on the installation start dialog.
- The installation starts. Do not perform any operation on the computer until the installation is completed.

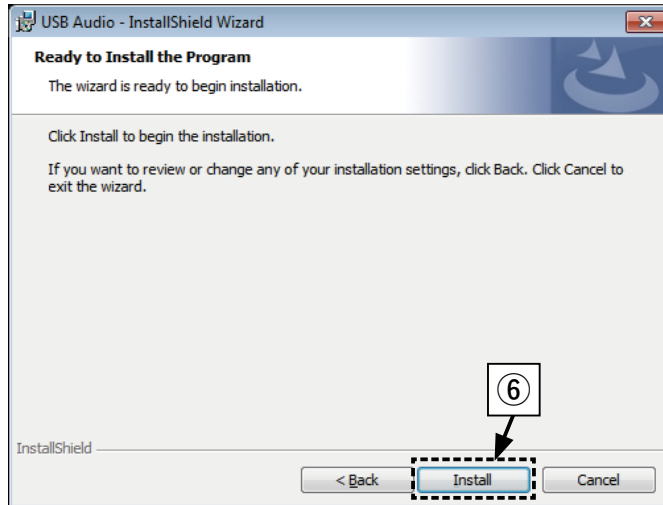

- ⑦ In the Windows security dialog, select “Always trust software from DandM Holdings Inc.”.
- ⑧ Click “Install”.



- ⑨ When the installation is completed, click “Finish”.

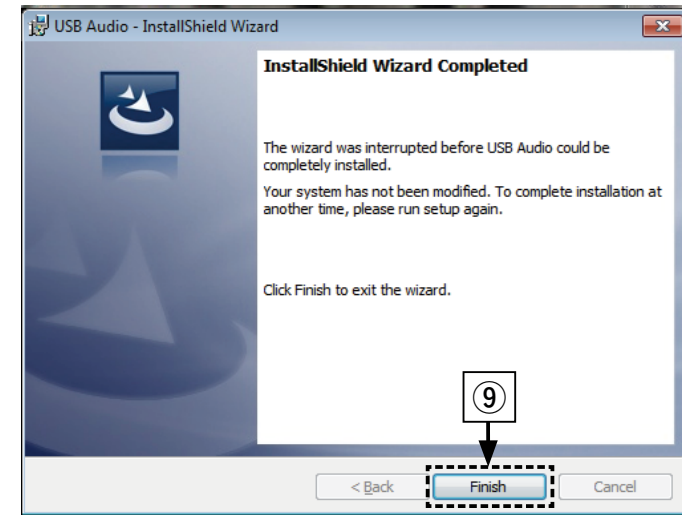

- 5 With the unit power off, connect the unit and computer using a USB cable (sold separately).**
- For the connection procedure, refer to the “Connecting a PC or Mac” (page 21) section.
- 6 Press POWER .**
- When the unit power is turned on, the computer automatically finds and connects to the unit.
- 7 Press INPUT to change the media mode to “USB-DAC”.**



8 Checking the installed driver

- ① Click the “Start” button and click “Control Panel” on the computer.
 - The control panel setting list is displayed.
- ② Click the “Sound” icon.
 - The sound menu window is displayed.
- ③ Check that there is a checkmark next to “Default Device” under “Marantz USB Audio” in “Digital Audio Interface” of the “Playback” tab.
 - When there is a checkmark for a different device, click “Marantz USB Audio” and “Set Default”.

9 Checking audio output

Outputs a TEST signal from the computer and checks the audio output from the USB-DAC function.

- ① Select “Digital Audio Interface” and click “Properties”.
 - The Digital Audio Interface Properties window is displayed.



- ② Click the “Advanced” tab.
 - ③ Select the sampling rate and bit rate to be applied to the D/A converter.
 - It is recommended that “24 bit, 192000 Hz (Studio Quality)” is selected.
 - ④ Click “Apply”.
 - ⑤ Click “Test”.
- Check that audio from this unit is output from the computer.

NOTE

- The dedicated driver must be installed in the computer before this unit is connected to a computer. Operation will not occur correctly if connected to the computer before the dedicated driver has been installed. Moreover, if the computer is running Windows XP as its OS, the computer’s speed will decrease significantly, and a computer restart may be required.
- Operation may fail in some computer hardware and software configurations.

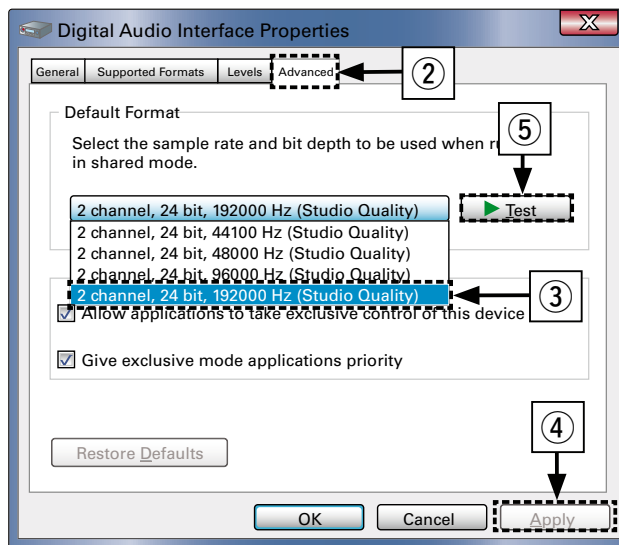

■ Playback

Install the desired player software on your computer beforehand.
Use the rear panel USB-DAC port to connect this unit to a computer.
For the connection procedure, refer to the “Connecting a PC or Mac”
( page 21) section.

1 Press INPUT to change the media mode to “USB-DAC”.

Start playback on the computer’s player software.

The input digital audio signal is displayed as shown.

“USB : xxxxk” or “USB : DSD xxxM”

(xxxx is the sampling frequency.)

- If the sampling frequency cannot be detected, “Unlock” will be displayed.

■ Files that can be played back

See “D/A converter” ( page 68).

NOTE

- Perform operations such as playback and pause on the computer. At this time, you cannot perform operations with buttons on this unit or the remote control.
- You can also control the volume and equalizer on the computer. Enjoy playing music at the desired volume.
- When this unit is functioning as a D/A converter, sound is not output from the computer’s speakers.
- If the computer is disconnected from this unit while the computer music playback software is running, the playback software may freeze. Always exit the playback software before disconnecting the computer.
- When an abnormality occurs on the computer, disconnect the USB cable and restart the computer.
- The sampling frequency of the music playback software and sampling frequency displayed on this unit may differ.



Connect and playback from a digital device (Coaxial/Optical)

- 1 **Connect digital device to this unit** ( [page 20](#)).
- 2 **Press INPUT to select the playback media mode to “Coaxial” or “Optical”.**

The input digital audio signal is displayed as shown.

“Coax: xxxk” or “Opt : xxxk”
(xxxx is the sampling frequency.)

- If the sampling frequency cannot be detected, “Unlock” will be displayed.

■ Files that can be played back

See “D/A converter” ( [page 68](#)).

NOTE

- Do not input non-PCM signals, such as Dolby Digital, and DTS. This causes noise and could damage the speakers.
- If the sampling frequency switches, such as from A mode to B mode in a CS broadcast, muting may operate for 1 – 2 seconds, cutting the sound.



Settings

Menu map

By default, this unit has recommended settings defined. You can customize this unit based on your existing system and your preferences.

Setting items	Description	Page
Timer Play	This unit can perform timer play by cooperating with your timer device.	54
Disp Info	Sets the information played during iPod and USB memory device playback.	54
iPod	Sets the information played during iPod playback.	54
USB	Sets the information played during USB memory device playback.	54
USB Resume	Switches the USB memory device resume playback on/off.	55
Digital Out	Switches the digital audio output on/off.	55
Auto Stnby	Sets whether to automatically switch the unit to the standby mode when the unit remains in the stop mode for more than 30 minutes.	55



Menu operation

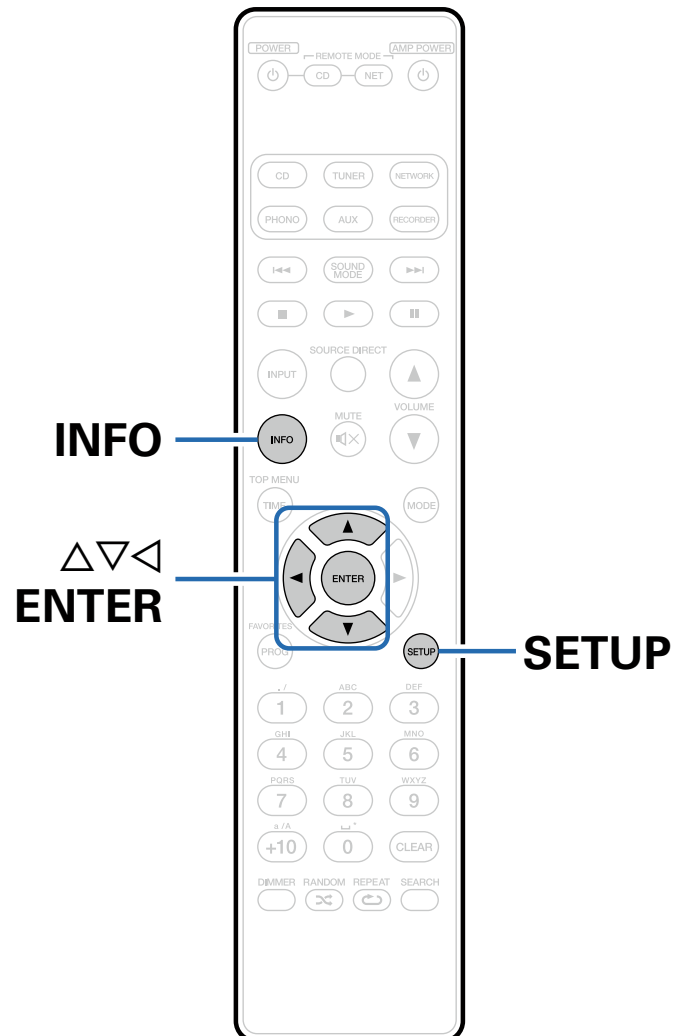

- 1 Press SETUP during stop mode.**
The menu is displayed on the display.
- 2 Use Δ / ∇ to select the menu to be set or operated, then press ENTER.**
- 3 Use Δ / ∇ change to desired setting.**
- 4 Press ENTER to enter the setting.**
 - To return to the previous item, press \triangleleft .
 - Exiting the Menu, press SETUP while the menu is displayed. The display returns to the normal display.



Timer Play

This unit can perform timer play by cooperating with your audio timer (see page 25 “Connecting the timer device”).

On : Timer play is set.

Off (Default) : Timer play is not set.

■ Using the timer play function

- 1 Turn on the power of the connected components.
- 2 Switch the amplifier's function to input from the connected unit.
- 3 Load a disc or connect an iPod or USB memory device.
- 4 Set the audio timer for the desired times.
 - For connection to audio timer and its operation, please refer to the instruction manual of your audio timer.
- 5 Turn the timer on.
 - The power of the components connected to the timer turns off.
 - When the set time is reached, the power of the different components automatically turns on and playback starts from the first track.

NOTE

- The timer play does not support the random play or program play.

Disp Info

Sets the information displayed during iPod or USB memory device playback.

iPod

Sets the information displayed during iPod playback.

Time (Default) : Displays the time information.

Title : Displays the title name.

Artist : Displays the artist name.

Album : Displays the album name.



- Press INFO to switch the information during playback.

USB

Sets the information displayed during USB memory device playback.

Time (Default) : Displays the time information.

Title : Displays the title name.

Artist : Displays the artist name.

Album : Displays the album name.



- Press INFO to switch the information during playback.



USB Resume

This unit stores the point at which playback of a file was stopped previously, and starts playback from the same point the next time playback is started.

On (Default) : Resume playback is set.

Remote : Resume playback is not set.

NOTE

- Resume playback works even if the USB memory device is disconnected and then reconnected. However, if a different USB memory device is connected, the resume information for the previous USB memory device is deleted.
- The resume information may be deleted when the USB memory device is removed and files are added or deleted.

Digital Out

Switches the digital audio output on/off.

On (Default) : Use the digital audio output connector.

Off : Do not use the digital audio output connector.



- When digital output is turned off, the "DOFF" indicator lights up on the display.
- The "Digital Out" has a memory retention function where the settings remain stored and unchanged even when the disc is changed or the power is turned off.

Auto Stnby

A standby status is established at the unit if a stopped status or a no external input signal status continues for 30 minutes or more.

On (Default) : Enable Auto Standby mode.

Off : Disable Auto Standby mode.



- When iPod is being charged, this unit enters the power standby mode after charging.



Tips



Contents

■ Tips	(57)	■ Troubleshooting	(58)
I want to enjoy analog output audio at higher quality	(57)	Power does not turn on / Power is turned off	(58)
I want to playback just the specified folder	(57)	Operations cannot be performed through the remote control unit.....	(59)
I want to stop the USB memory device from automatically starting playback.	(57)	Display on this unit shows nothing	(59)
I want to display the title, etc. of the file currently playing back on the iPod on this unit's display.....	(57)	No sound comes out	(60)
I want to playback WAV files.....	(57)	Sound is interrupted or noise occurs.....	(60)
I want to use this unit's remote control to operate a Marantz network audio player	(57)	Cannot playback CDs	(61)
I want to display Super Audio CD text	(57)	iPod cannot be played back.....	(61)
		USB memory devices cannot be played back	(62)
		File names on the iPod/USB memory device are not displayed properly	(63)
		PC or Mac files cannot be played back.....	(63)



Tips

I want to enjoy analog output audio at higher quality

- Set “Digital Out” on the menu to “Off” ( [page 55](#)).
- Press the DIMMER button to turn the display off ( [page 29](#)).

I want to playback just the specified folder

- Press the MODE button to set the playback range to “Folder mode” ( [page 35, 42](#)).

I want to stop the USB memory device from automatically starting playback

- Set “USB Resume” to “Off” in the menu ( [page 55](#)).

I want to display the title, etc. of the file currently playing back on the iPod on this unit’s display

- Press the MODE button to set Remote iPod mode ( [page 39](#)).

I want to playback WAV files

- This unit can playback WAV files that are stored on a USB memory device ( [page 41](#)).

I want to use this unit’s remote control to operate a Marantz network audio player

- Switch the remote mode of the remote control ( [page 16](#)).
- Also, refer to the instruction manual of the network audio player.

I want to display Super Audio CD text

- This unit supports Super Audio CD text. Press the INFO button to switch the display information.





Troubleshooting

If a problem should arise, first check the following:

1. Are the connections correct?
2. Is the set being operated as described in the owner's manual?
3. Are the other devices operating properly?

If this unit does not operate properly, check the items listed in the table below. Should the problem persist, there may be a malfunction. In this case, disconnect the power immediately and contact your store of purchase.

■ Power does not turn on / Power is turned off

Symptom	Cause / Solution	Page
Power is not turned on.	<ul style="list-style-type: none"> • Check whether the power plug is correctly inserted into the power outlet. • This unit is in standby mode. Press  on the unit or POWER  on the remote control. 	26 28
Power automatically turns off.	<ul style="list-style-type: none"> • The Auto Standby mode is set. When Auto Standby mode is set to On, if the unit remains in the stopped state and no operations are performed or if there are no input signals for approximately 30 minutes, the unit automatically switches to standby mode. To disable Auto Standby mode, set "Auto Stnby" on the menu to "Off". 	55



■ Operations cannot be performed through the remote control unit

Symptom	Cause / Solution	Page
Operations cannot be performed through the remote control unit.	• Batteries are worn out. Replace with new batteries.	<u>5</u>
	• Operate the remote control unit within a distance of about 7 m from this unit and at an angle of within 30°.	<u>5</u>
	• Remove any obstacle between this unit and the remote control unit.	–
	• Insert the batteries in the proper direction, checking the ⊕ and ⊖ marks.	<u>5</u>
	• The set's remote control sensor is exposed to strong light (direct sunlight, inverter type fluorescent bulb light, etc.). Move the set to a place in which the remote control sensor will not be exposed to strong light.	–
	• When using a 3D video device, the remote control unit of this unit may not function due to effects of infrared communications between units (such as TV and glasses for 3D viewing). In this case, adjust the direction of units with the 3D communications function and their distance to ensure they do not affect operations from the remote control unit of this unit.	–
	• Press the REMOTE MODE CD button to switch the remote control to the CD operation mode.	<u>12</u>
	• When using this unit independently, set the switch to "INTERNAL".	<u>24</u>

■ Display on this unit shows nothing

Symptom	Cause / Solution	Page
Display is off.	• Press the DIMMER button to switch to any setting other than off.	<u>29</u>



■ No sound comes out

Symptom	Cause / Solution	Page
No sound is produced or sound is distorted.	<ul style="list-style-type: none"> • Check the connections for all devices. • Insert connection cables all the way in. • Check that input connectors and output connectors are not reversely connected. • Check cables for damage. • Check the amplifier's functions and controls and adjust as necessary. 	17 , 18 , 19 , 20 , 21 , 22 , 24 , 25 , 26 – – –

■ Sound is interrupted or noise occurs

Symptom	Cause / Solution	Page
During playback from the USB memory device, sound is occasionally interrupted.	<ul style="list-style-type: none"> • When the transfer speed of the USB memory device is slow, sound may occasionally be interrupted. 	–
Sound is interrupted during playback of tracks saved on a PC.	<ul style="list-style-type: none"> • Sound may be interrupted due to the hardware and software configurations of the PC. 	–



■ Cannot playback CDs

Symptom	Cause / Solution	Page
Cannot playback when the ► button is pressed, or cannot correctly playback a specific part of the disc.	<ul style="list-style-type: none"> The CD is dirty or scratched. Either clean the CD, or insert a different CD. 	<u>70</u>
Cannot playback CD-R/CD-RW.	<ul style="list-style-type: none"> CDs cannot be played back unless they have been finalized. Use a finalized disc. This may be caused by poor recording conditions, or the disc itself may be of poor quality. Use a correctly recorded disc. The DATA CD playback function of this unit only supports playback of MP3 and WMA files. 	<u>64, 71</u> – <u>65</u>
"0 0:00" is displayed.	<ul style="list-style-type: none"> "0 0:00" is displayed if a disc that cannot be played is loaded. 	<u>69</u>
"No Disc" is displayed.	<ul style="list-style-type: none"> "No Disc" is displayed if the disc is loaded upside-down or if no disc is loaded. 	<u>69</u>

■ iPod cannot be played back

Symptom	Cause/Solution	Page
iPod cannot be connected or "Check iPod" is displayed.	<ul style="list-style-type: none"> When using iPod by connecting it to the USB port, some iPod variations are not supported. When iPod is connected by using a USB cable other than the genuine cable, iPod may not be recognized. Use a genuine USB cable. 	<u>23</u> –



■ USB memory devices cannot be played back

Symptom	Cause/Solution	Page
"No Device", "Check FS" or "Check Device" is displayed.	<ul style="list-style-type: none"> • This unit may not recognize the USB memory device due to poor connection, etc. Make sure that the connection is made properly by taking actions such as disconnecting and reconnecting the USB memory device. • USB memory devices of a mass storage class are supported. • This unit does not support a connection through a USB hub. Connect the USB memory device directly to the USB port. • The USB memory device must be formatted to FAT16 or FAT32. • Not all USB memory devices are guaranteed to work. Some USB memory devices are not recognized. When using a type of portable hard disc drive compatible with the USB connection that requires power from an AC adapter, use the AC adapter that came with the drive. 	<p><u>22</u></p> <p>–</p> <p>–</p> <p>–</p> <p>–</p>
Files on the USB memory device are not displayed or "Empty" is displayed.	<ul style="list-style-type: none"> • Files of a type not supported by this unit are not displayed. • This unit can display a file structure with up to 8 levels, up to 700 folders and up to 65535 files in total. Modify the folder structure of the USB memory device. • When multiple partitions exist on the USB memory device, only files on the first partition are displayed. 	<p><u>65</u></p> <p>–</p> <p>–</p>
Files on a USB memory device cannot be played.	<ul style="list-style-type: none"> • Files are created in a format that is not supported by this unit. Check the formats supported by this unit. • You are attempting to play a file that is copyright protected. Files that are copyright protected cannot be played on this unit. • When "< Not Support" is displayed, use the ◀ button on the remote control unit to select a different file. 	<p><u>65</u></p> <p>–</p> <p>–</p>



■ File names on the iPod/USB memory device are not displayed properly

Symptom	Cause/Solution	Page
The file names are not displayed properly ("***", etc.).	<ul style="list-style-type: none"> Characters that cannot be displayed are used. This is not a malfunction. On this unit, characters that cannot be displayed are replaced with a "*". 	–

■ PC or Mac files cannot be played back





Symptom	Cause/Solution	Page
The PC or Mac cannot recognize this unit.	<ul style="list-style-type: none"> Check the OS of the PC or Mac connected to this unit. A specialized driver needs to be installed when using a Windows PC. 	<u>45</u> <u>45</u>



Appendix

Playable media

Discs

Playable media	
Super Audio CD	
CD	
CD-R	
CD-RW	

Super Audio CD

There are three types of Super Audio CDs:

- ① Single layer discs
Single layer Super Audio CD with just an HD layer.
- ② Dual layer discs
Super Audio CD with a double HD layer, offering extended playing time and high sound quality.
- ③ Hybrid discs
Two-layer Super Audio CD with an HD layer and a CD layer.
The signals on the CD layer can be played on a regular CD player.

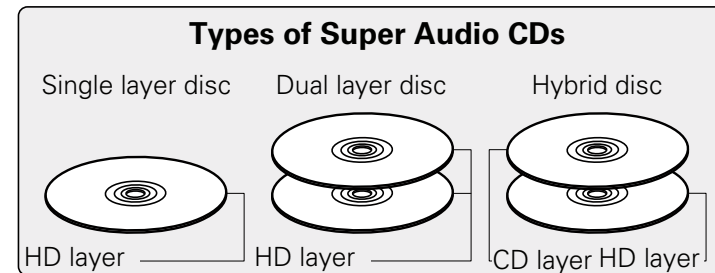

The HD layer is a layer of high density signals for Super Audio CDs. The CD layer is the layer of signals that can be read on a regular CD player.



- When the SOUND MODE button is used to select "MULTI", down mixed audio is output from the L and R channels.

NOTE

- Some discs and some recording formats may not be playable.
- Non-finalized discs cannot be played.



DATA CD

CD-R and CD-RW discs created in the format described below can be played.

■ Writing software format

ISO9660 level 1, 2

Expansion format (Juliet.Romeo)

- When written in other formats, it may not be possible to play the disc properly.

■ Playable files

Playable files (Extension)	File specification
MP3 (.mp3)	<ul style="list-style-type: none"> • Sampling frequency : 32 / 44.1 / 48 kHz • Bit rate : 32 kbps to 320 kbps • Format : MPEG1 Audio Layer 3
WMA (.wma)	<ul style="list-style-type: none"> • Sampling frequency : 32 / 44.1 / 48 kHz • Bit rate : 64 kbps to 192 kbps • Format : Windows Media Audio

■ Maximum number of playable files and folders

Maximum number of files: 1,000

Maximum number of folders: 255

NOTE

- Be sure to give files the extension “.mp3” or “.wma” Files with any other extensions or files with no extensions cannot be played.
- Recordings you have made should only be used for your personal enjoyment, and as per copyright laws may not be used in other ways without permission of the copyright holder.



- Only music files that are not copyright-protected can be played on this set.
 - Contents downloaded from pay sites on the Internet are copyright protected. Also, files encoded in WMA format when ripped from a CD, etc., on a computer may be copyright protected, depending on the computer's settings.

USB memory device

■ USB-compatible file systems

FAT16 or FAT32

- If the USB memory device is divided into multiple partitions, only the top drive can be selected.

■ Tag data

ID3-TAG (Ver.1.x and 2.x)

WMA-TAG

AAC-TAG

The title, artist, and album tag data are supported.



■ Playable files

Playable files (Extension)	File specification
MP3 (.mp3)	<ul style="list-style-type: none"> • Sampling frequency : 32 / 44.1 / 48 kHz • Bit rate : 32 kbps to 320 kbps • Format : MPEG1 Audio Layer 3
WMA (.wma)	<ul style="list-style-type: none"> • Sampling frequency : 32 / 44.1 / 48 kHz • Bit rate : 48 kbps to 320 kbps • Format : Windows Media Audio
AAC (.m4a)	<ul style="list-style-type: none"> • Sampling frequency : 32 / 44.1 / 48 kHz • Bit rate : 64 kbps to 192 kbps • Format : Advanced Audio Codec
Linear PCM (.wav)	<ul style="list-style-type: none"> • Sampling frequency : 32 / 44.1 / 48 kHz • Bit length : 16 bit • Format : Linear PCM

■ Maximum number of playable files and folders

Maximum number of files: 65,535

Maximum number of folders: 700



- Only music files that are not copyright-protected can be played on this set.
 - Contents downloaded from pay sites on the Internet are copyright protected. Also, files encoded in WMA format when ripped from a CD, etc., on a computer may be copyright protected, depending on the computer's settings.
 - When audio from files in the USB memory device is output from the digital audio output connector, the sampling frequency is converted to 44.1 kHz for output.

NOTE

- It is not compatible with an MP3 player, digital camera, a USB device for a mobile phone, etc.
- The unit cannot charge a USB device.



Playback order of MP3/WMA/AAC/WAV files

When there are multiple folders containing MP3/WMA/AAC/WAV files, the playback order of folders is automatically set when this unit reads the media. The files in each folder are played back in the order in which the files were recorded on the media, from the oldest date and time.

CD-R/CD-RW

For playback of files on CD-R or CD-RW, files in all folders on the first layer are played first, next on the second layer, then next on the third layer, and so on in this order.

USB memory device

For playback of files recorded on USB, files in the first folder on the first layer are played first, next folders on the second layer in the folder, then next on the third layer, and so on in this order. Then accordingly files on another first layer are played.



- The playback order displayed on a PC may differ from the actual playback order.
- The playback order with a CD-R/CD-RW may differ, depending on the writing software.

NOTE

- The playback order may differ from the order in which the folders or files were recorded if you delete or add a folder or file on USB. This occurs because of data recording specifications and is not a malfunction.

About Discs and Files

Files, such as MP3/WMA/AAC/WAV etc., recorded on CD-R/-RW and USB memory device are divided into large segments (folders) and small segments (files). Files are stored in folders, and folders can be placed for storage in a hierarchy. The unit can recognize up to 8 levels of folders.

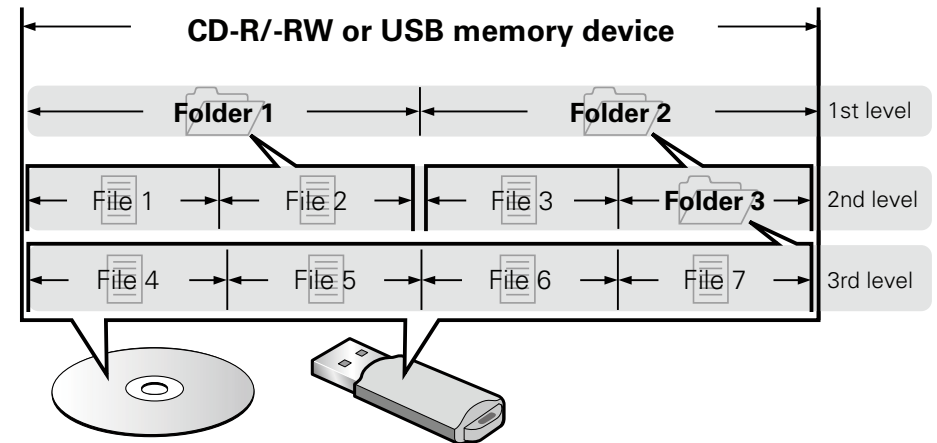

- When writing MP3/WMA etc. files on a CD-R/-RW disc, set the writing software's format to "ISO9660". The files may not play properly if they are recorded in other formats. For details, refer to the instructions of your writing software.



D/A converter

■ Supported audio formats

USB-DAC

Signal format	Specification
DSD (2-channel)	<ul style="list-style-type: none"> • Sampling frequency : 2.8224/5.6448 MHz • Bit length : 1 bit
Linear PCM (2-channel)	<ul style="list-style-type: none"> • Sampling frequency : 32/44.1/48/88.2/96/176.4/192 kHz • Bit length : 16/24 bit

NOTE

- Digital audio output is stopped during DSD signal or linear PCM signals with sampling frequencies of 32 kHz playback.

Coaxial/Optical

Signal format	Specification
Linear PCM (2-channel)	<ul style="list-style-type: none"> • Sampling frequency : 32/44.1/48/64/88.2/96/176.4/192 kHz • Bit length : 16/24 bit



Cautions on using media

Inserting a disc

- Set the disc in the tray label side up.
- Make sure the disc tray is fully open when inserting the disc.
- Place the discs flatly, 12 cm discs in the outer tray guide (Figure 1), 8 cm discs in the inner tray guide (Figure 2).

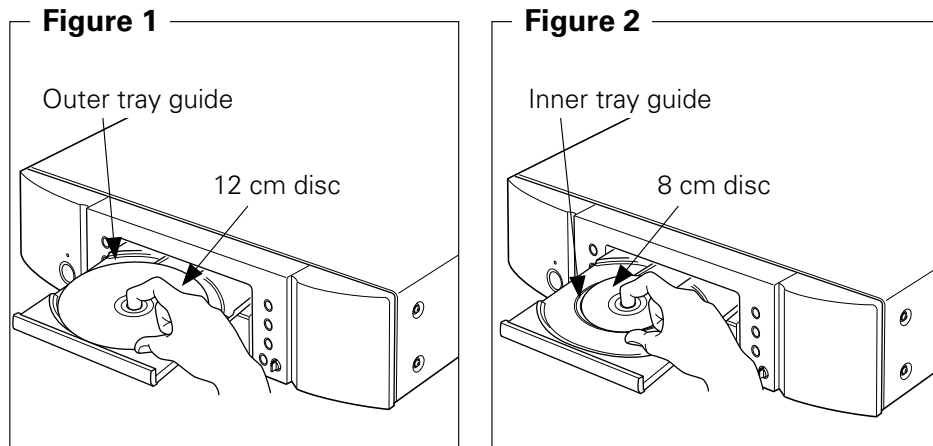

- Place 8 cm discs in the inner tray guide without using an adapter.



- "0 0:00" is displayed if a disc that cannot be played is loaded.
- "No Disc" is displayed if the disc is loaded upside-down or if no disc is loaded.

NOTE

- Only load one disc at a time. Loading two or more discs can damage the unit or scratch the discs.
- Do not use cracked or warped discs or discs that have been repaired with adhesive, etc.
- Do not use discs on which the sticky part of cellophane tape or labels is exposed or on which there are traces of where labels have been removed. Such discs can get caught inside the player and damage it.
- Do not use discs in special shapes, as they may damage the player.

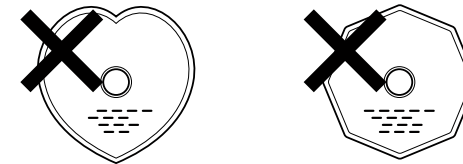

- Do not push the disc tray in by hand when the power is off.
- Doing so could damage the set.
- If the unit is left in a room full of smoke from cigarettes, etc., for long periods of time, the surface of the optical pickup may get dirty, preventing it from receiving signals properly.



How to handle media

- Do not get fingerprints, oil or dirt on discs.
- Take special care not to scratch discs when removing them from their cases.
- Do not bend or heat discs.
- Do not enlarge the hole in the center.
- Do not write on the labeled (printed) surface with ball-point pens, pencils, etc., or stick new labels on discs.
- Condensation may form on discs if they are moved suddenly from a cold place (outdoors for example) to a warm place, but do not try to dry discs with a hairdryer, etc.
- Do not eject a USB memory device or turn off the unit while a USB memory device is being played. This may result in malfunction or loss of the USB memory device's data.
- Do not attempt to open or modify a USB memory device.
- USB memory device and files can be damaged by static electricity. Do not touch the metal contacts of an USB memory device with your fingers.
- Do not use warped USB memory device.
- After use, be sure to remove any disc or USB memory device, and store it in its proper case, to avoid dust, scratches and deformation.
- Do not store discs in the following places:
 1. Places exposed to direct sunlight for long periods of time
 2. Dusty or humid places
 3. Places exposed to heat from heaters, etc.

Cleaning discs

- If there are fingerprints or dirt on a disc, wipe them off before using the disc.
- Use a commercially available disc cleaning set or a soft cloth to clean discs.

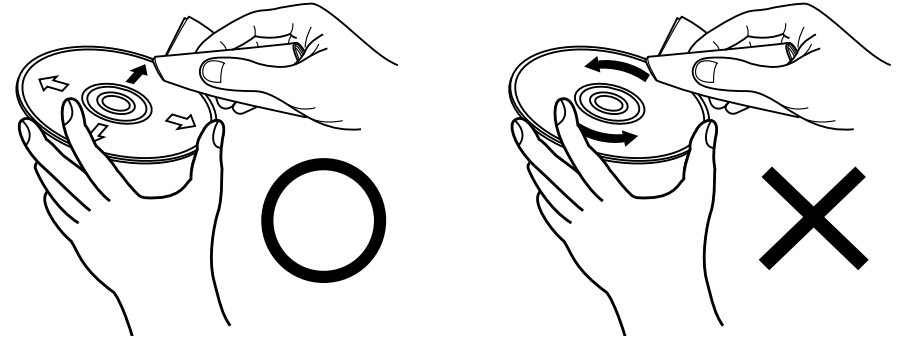

Gently wipe the disc from the inside towards the outside.

Do not wipe with a circular motion.

NOTE

- Do not use record spray, antistatic agents, benzene, thinner or other solvents.



Explanation of terms

B

Bit rate

This is the amount of audio data recorded on a disc that is read in one second.

D

Dynamic range

The difference between the maximum, undistorted sound level and the minimum sound level that is discernible above the noise emitted by the device.

F

Finalizing

This process enables CDs recorded with a CD recorder or drive to be played by other players.

L

Linear PCM

This is an uncompressed PCM (Pulse Code Modulation) signal. This is the same system used for CD audio but uses 192 kHz, 96 kHz, and 48 kHz sampling frequencies on Blu-ray Disc or DVD and provides higher resolution than CD.

M

MP3 (MPEG Audio Layer 3)

This is an internationally standardized audio data compression scheme, based on the "MPEG-1" video compression standard. It compresses the data volume to about one eleventh its original size while maintaining sound quality roughly equivalent to a music CD.

S

Sampling frequency

Sampling involves taking a reading of a sound wave (analog signal) at regular intervals and expressing the height of the wave at each reading in digitized format (producing a digital signal).

The number of readings taken in one second is called the "sampling frequency". The larger the value, the closer the reproduced sound is to the original.

W

WMA (Windows Media Audio)

This is the audio compression technology developed by Microsoft Corporation.

To encode WMA files, only use applications authorized by Microsoft Corporation. If you use an unauthorized application, the file may not work properly.



Trademark information



Adobe, the Adobe logo and Reader are either registered trademarks or trademarks of Adobe Systems Incorporated in the United States and/or other countries.



Specifications

■ Audio performance

• Analog output

Channels:

Playable frequency range:

Playable frequency response:

S/N:

Dynamic range:

Harmonic distortion:

Wow & flutter:

Output level:

Headphone output:

Signal type:

Sampling frequency:

Usable discs:

• Digital output

Coaxial:

Optical:

Emission wavelength:

• Digital input signal format

Format:

Coaxial input:

Optical

Optical input:

Optical wavelength:

[Super Audio CD]

2 channels

2 Hz – 100 kHz

2 Hz – 60 kHz (–3 dB)

110 dB (Audible range)

106 dB (Audible range)

0.0012 % (1 kHz, Audible range)

Below measurable limits

1.7 V (10 k Ω /kohms)

30 mW / 32 Ω /ohms
(variable maximum)

1-bit DSD

2.8224 MHz

Super Audio CD

–

–

–

Digital audio interface (Linear PCM)

0.5 Vp-p / 75 Ω /ohms

More than –27 dBm

660 nm

[CD]

2 channels

2 Hz – 20 kHz

2 Hz – 20 kHz (\pm 0.5 dB)

110 dB

101 dB

0.0018 % (1 kHz)

Below measurable limits

2.4 V (10 k Ω /kohms)

30 mW / 32 Ω /ohms
(variable maximum)

16-bit linear PCM

44.1 kHz

Compact Disc

0.5 Vp-p / 75 Ω /ohms

–15 – –21 dBm

660 nm



■ General

Power supply:	AC 230 V, 50/60 Hz
Power consumption:	29 W
Power consumption in standby mode:	0.2 W

For purposes of improvement, specifications and design are subject to change without notice.



Index

A

Accessories.....	4
Auto Standby.....	55

B

Bit rate.....	65, 68, 71
Brightness.....	29

C

Cables used for connections.....	17
Connection	
Amplifier.....	18
AV receivers.....	19
CD player.....	20
D/A converters.....	19
iPod.....	22
PC.....	21
Power cord.....	26
Remote control.....	24
Timer device.....	25
USB memory device.....	22

D

Direct search.....	32
Display.....	10
Dynamic range.....	71

F

Finalizing.....	71
Front Panel.....	8

I

Installing the driver software.....	45
-------------------------------------	----

M

Menu map.....	52
---------------	----

P

Playback	
AAC.....	41, 66, 67
CD.....	31
DATA CD.....	34
iPod.....	37
MP3.....	41
Super Audio CD.....	31
USB memory device.....	41
WAV.....	41
WMA.....	34, 41
Playback mode	
Program playback.....	33
Random.....	32, 35, 39, 42
Remote iPod mode.....	39
Repeat.....	32, 35, 39, 42

R

Rear panel.....	11
Remote control unit.....	12
Inserting the batteries.....	5

S

Sampling frequency.....	65, 68, 71
Select the playback media mode.....	29

T

Tips.....	57
Troubleshooting.....	58
Turning the power on.....	28

U

USB-DAC.....	45
--------------	----



■ Dimensions

Unit : mm

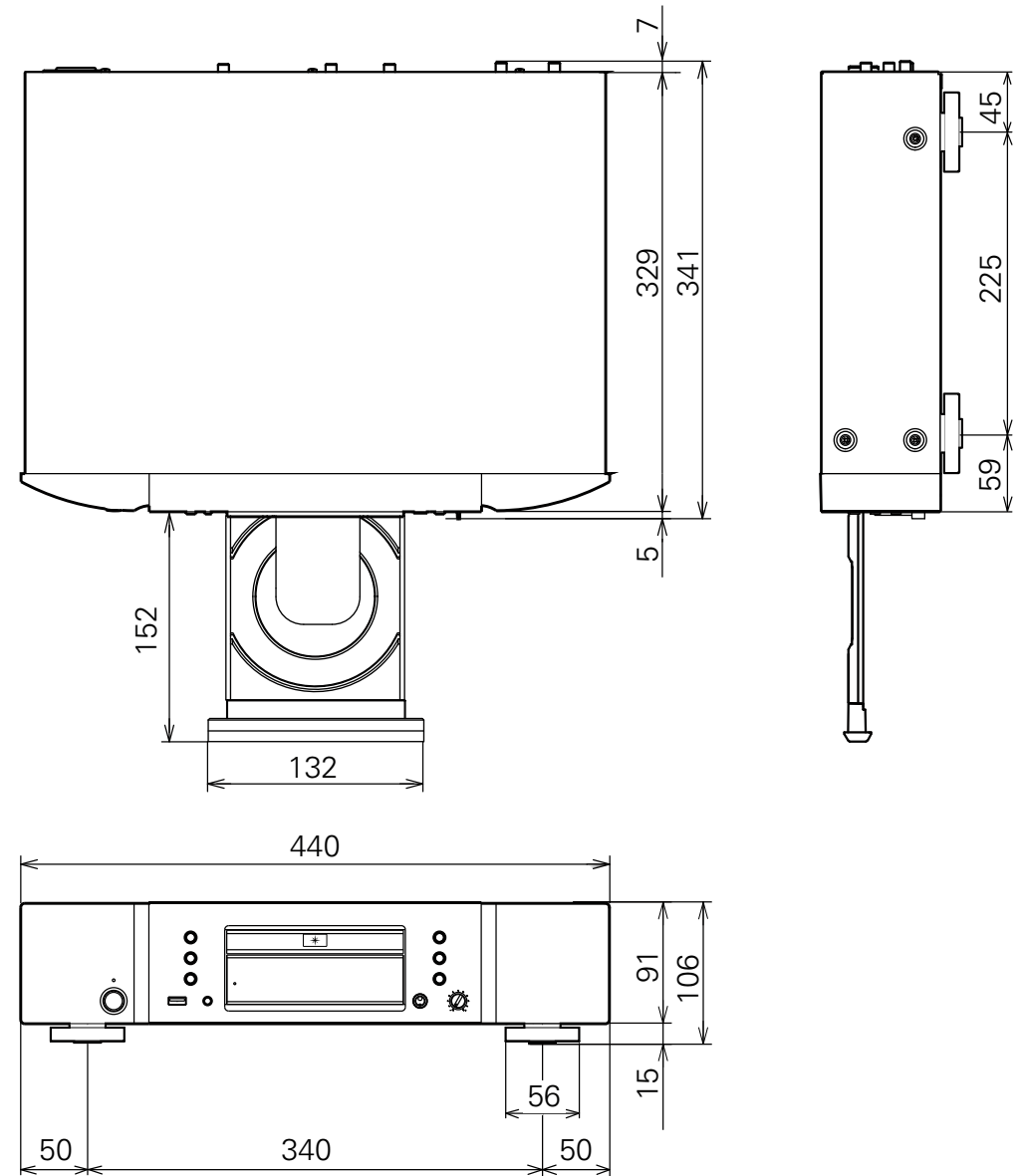

■ Weight : 8.0 kg



www.marantz.com

You can find your nearest authorized distributor or dealer on our website.

marantz[®] is a registered trademark.

D&M Holdings Inc.
3520 10284 00AM